

Over 40 years
serving Irish
Industry

SINGLE SOURCE

Over 220 New Items 7th Issue

18 Quality Brands



Available From:

BGS[®]
technic

 **TELWIN**

HSS Drill Bit Set



19-pcs. 1-10 mm, DIN 338

- M 10 Rolled
- MG 10 Ground
- ME 10 Cobalt

25-pcs. 1-13 mm, DIN 338

- M 13 Rolled
- MG 13 Ground
- ME 13 Cobalt

HSS Tap and Die Set

31-pcs. M3-M12
taps and dies

GS 25

44-pcs. M3-M12
taps, dies and drills

GW 12

54-pcs. M3-M20
taps and dies

GW 20

43-pcs. MF3-MF20
taps and dies

GW 43



HSS Tap Set with Drill Bits



15-pcs.
Single-Hand Taps DIN 352
M3/M4/M5/M6/M8/M10/M12
+ HSS ground drills DIN 338
2,5/3,3/4,2/5,0/6,8/8,5/10,2 mm
Tap-Wrench DIN 1814, size 1,5

EGB 15

HSS Countersink Set

6-pcs.
6,3/8,3/10,4/12,4/16,5/20,5 mm

KS6

KS6 Cobalt



HSS Step Drill Set



3-pcs. 4-12 / 4-20 / 4-30 mm

STB 3

STB 3 Cobalt

HSS Tube and Sheet Drill Set

3-pcs. 3-14 / 6-20 / 16-30,5 mm

B 3



HSS Drill Magazines



170-pcs. DIN 338
1,0 - 8,0 mm - 10 pcs. each
8,5 - 10,0 mm - 5 pcs. each

M 170 Rolled

MG 170 Ground

70-pcs. DIN 338
1,0 - 5,0 mm - 5 pcs. each
5,5 - 7,5 mm - 3 pcs. each
8,0 - 10,0 mm - 2 pcs. each

ME 70 Cobalt

**HSS Core Drills
with weldon shank (3/4")**

4-pcs.
14/18/20 mm Ø x 30 mm length
+ Ejector Pin

KB3



HSS Drills DIN 338

Ø mm	L mm	L2 mm	HSS-rolled		HSS-ground		HSS-cobalt	
			Qty./pack	Qty./DIY wallet	Qty./pack	Qty./DIY wallet	Qty./pack	Qty./DIY wallet
1,00	34	12	10	3	10	3	10	1
1,50	40	18	10	3	10	3	10	1
2,00	49	24	10	3	10	3	10	1
2,50	57	30	10	3	10	3	10	1
3,00	61	33	10	3	10	3	10	1
3,50	70	39	10	2	10	2	10	1
4,00	75	43	10	2	10	2	10	1
4,50	80	47	10	2	10	2	10	1
5,00	86	52	10	2	10	2	10	1
5,50	93	57	10	1	10	1	10	1
6,00	93	57	10	1	10	1	10	1
6,50	101	63	10	1	10	1	10	1
7,00	109	69	10	1	10	1	10	1
7,50	109	69	10	1	10	1	10	1
8,00	117	75	10	1	10	1	10	1
8,50	117	75	10	1	10	1	10	1
9,00	125	81	10	1	10	1	10	1
9,50	125	81	10	1	10	1	10	1
10,00	133	87	10	1	10	1	10	1
10,50	133	87	5	1	5	1	5	1
11,00	142	94	5	1	5	1	5	1
11,50	142	94	5	1	5	1	5	1
12,00	151	101	5	1	5	1	5	1
12,50	151	101	5	1	5	1	5	1
13,00	151	101	5	1	5	1	5	1

HSS Blacksmith Drills

Ø mm	Shank	HSS-rolled	HSS-ground	HSS-cobalt
11,00	10 x 30	✓	✓	✓
12,00	10 x 30	✓	✓	✓
13,00	10 x 30	✓	✓	✓
13,50	10 x 30	✓	✓	✗
14,00	10 x 30	✓	✓	✓
14,50	10 x 30	✓	✓	✗
15,00	10 x 30	✓	✓	✓
15,50	10 x 30	✓	✓	✗
16,00	10 x 30	✓	✓	✓
16,50	13 x 35	✓	✓	✗
17,00	13 x 35	✓	✓	✓
17,50	13 x 35	✓	✓	✗
18,00	13 x 35	✓	✓	✓
18,50	13 x 35	✓	✓	✗
19,00	13 x 35	✓	✓	✓
19,50	13 x 35	✓	✓	✗
20,00	13 x 35	✓	✓	✓
21,00	13 x 40	✓	✗	✗
22,00	13 x 40	✓	✗	✗
23,00	13 x 40	✓	✗	✗
24,00	13 x 40	✓	✗	✗
25,00	13 x 40	✓	✗	✗
26,00	13 x 40	✓	✗	✗
28,00	13 x 40	✓	✗	✗
30,00	13 x 40	✓	✗	✗

HSS Drills DIN 338, left-hand cutting



Ø mm	L mm	L2 mm	Qty./pack
3,0	61	33	10
4,0	75	43	10
5,0	86	52	10
6,0	93	57	10
8,0	117	75	5
10,0	133	87	5
12,0	151	101	5

Stubby Drills HSS-G fully ground, extra short



Ø mm	L mm	L2 mm
3,00	31	13
3,20	31	13
3,50	40	15
4,00	40	15
4,90	48	20
5,00	50	22
5,50	50	22
6,00	52	24

Spot Weld Drills HSS-E (Co5)



Ø mm	L m
6,00	66
8,00	79
10,00	89

Centre Drills DIN 333 A 60° HSS



Ø mm	Shank
1,00	3,15
1,25	3,15
1,60	4,00
2,00	5,00
2,50	6,30
3,15	8,00
4,00	10,00
5,00	12,50
6,30	16,00

Above prices are subject to VAT.

TURBO STEP

HSS Turbo Step Drill sets



19-pcs. 1-10 mm, DIN 338

KG 10 TURBO STEP

25-pcs. 1-13 mm, DIN 338

KG 13 TURBO STEP



5-pcs. 4/5/6/8/10 mm
DIN 338

MG5 TURBO STEP



HSS Turbo Step Drills DIN 338

Ø mm	L mm	L2 mm	Qty./pack	Qty./DIY wallet	Ø mm	L mm	L2 mm	Qty./pack	Qty./DIY wallet
1,00	34	12	10	1	6,50	101	63	10	1
1,50	40	18	10	1	6,80	109	69	10	1
2,00	49	24	10	1	7,00	109	69	10	1
2,50	57	30	10	1	7,50	109	69	10	1
3,00	61	33	10	1	8,00	117	75	10	1
3,20	65	36	10	1	8,50	117	75	10	1
3,50	70	39	10	1	9,00	125	81	10	1
4,00	75	43	10	1	9,50	125	81	10	1
4,20	75	43	10	1	10,00	133	87	10	1
4,50	80	47	10	1	10,50	133	87	5	1
4,90	86	52	10	1	11,00	142	94	5	1
5,00	86	52	10	1	11,50	142	94	5	1
5,20	86	52	10	1	12,00	151	101	5	1
5,50	93	57	10	1	12,50	151	101	5	1
6,00	93	57	10	1	13,00	151	101	5	1

TURBO STEP INOX



HSSE (Co5) Turbo Step Drills DIN 338

Ø mm	L mm	L2 mm	Qty./pack	Qty./DIY wallet
4,00	75	43	10	1
5,00	86	52	10	1
6,00	93	57	10	1
8,00	117	75	10	1
10,00	133	87	10	1

HSS Turbo Step Drill set

5-pcs. 4/5/6/8/10 mm
DIN 338

ME5 T-STEP INOX



TURBO STEP

TURBO STEP INOX

Standard HSS Twist Drill



Application video





Taper Shank Drills DIN 345 HSS



Ø mm	Taper	L mm	L2 mm
13,00	1	182	101
13,50	1	189	108
14,00	1	189	108
14,50	2	212	114
15,00	2	212	114
15,50	2	218	120
16,00	2	218	120
16,50	2	223	125
17,00	2	228	130
17,50	2	228	130
18,00	2	228	130
18,50	2	233	135
19,00	2	233	135
19,50	2	238	140
20,00	2	238	140
20,50	2	243	145
21,00	2	243	145
21,50	2	248	150
22,00	2	248	150
22,50	2	253	155
23,00	2	253	155
23,50	3	276	155
24,00	3	281	160
24,50	3	281	160
25,00	3	281	160
25,50	3	286	165
26,00	3	286	165
26,50	3	286	165
27,00	3	291	170
27,50	3	291	170
28,00	3	291	170
28,50	3	296	175
29,00	3	296	175
29,50	3	296	175
30,00	3	296	175
30,50	3	301	180
31,00	3	301	180
31,50	3	301	180
32,00	4	334	185

Core Drills HSS-E (Co5), weldon shank (3/4")

Ø mm			
	30 mm	50 mm	110 mm
12,0	✓	✓	X
13,0	✓	✓	X
14,0	✓	✓	X
15,0	✓	✓	X
16,0	✓	✓	X
18,0	✓	✓	X
19,0	✓	✓	X
20,0	✓	✓	✓
22,0	✓	✓	✓
24,0	✓	✓	✓
25,0	✓	✓	X
26,0	✓	✓	✓
27,0	✓	✓	X
28,0	✓	✓	✓
29,0	✓	✓	X
30,0	✓	✓	✓
32,0	✓	✓	✓
35,0	✓	✓	X
38,0	✓	X	X
40,0	✓	✓	X
42,0	X	✓	X
45,0	✓	X	X
48,0	✓	X	X
50,0	✓	X	X
55,0	✓	X	X
60,0	✓	X	X

Reduction Sleeves DIN 2185



Outside / Inside	L mm
2 / 1	92
3 / 1	99
3 / 2	112
4 / 1	124
4 / 2	124
4 / 3	140
5 / 3	156
5 / 4	171

Drill Drifts DIN 317



Outside / Inside	L mm
1 + 2	140
3	190
4	225
5 + 6	265

Drill Chuck Arbor DIN 238



Taper	Cone	L mm
2	B 16	112
3	B 16	131
4	B 16	156

MT holder for magnetic core drills



Size	€
MT2	210,00
MT3	213,00

Magnetic bit holder with spring clip

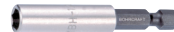

Drive	L mm
1/4" E 6,3	60
1/4" E 6,3	150
1/4" E 6,3	200
1/4" E 6,3	250

Pin for Core Drills with weldon shank (3/4")

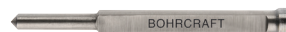

For	Depth	Size
HSS	30	12-60
HSS	50	12-60

**Twist Drills DIN 340 HSS-G
Fully Ground, Split Point
long series**



Ø mm	L mm	L2 mm
1,00	56	33
1,50	70	45
2,00	85	56
2,50	95	62
3,00	100	66
3,50	112	73
4,00	119	78
4,50	126	82
5,00	132	87
5,50	139	91
6,00	139	91
6,50	148	97
7,00	156	102
7,50	156	102
8,00	165	109
8,50	165	109
9,00	175	115
9,50	175	115
10,00	184	121
10,50	184	121
11,00	195	128
11,50	195	128
12,00	205	134
12,50	205	134
13,00	205	134

**Twist Drills DIN 1869 HSS-G
Fully Ground, Split Point
extra long series**



Ø mm	L mm	L2 mm	Ø mm	L mm	L2 mm
Series 1			Series 2		
2,00	125	85	2,00	-	-
2,50	140	85	2,50	-	-
3,00	150	100	3,00	190	130
3,50	165	115	3,50	210	145
4,00	175	120	4,00	220	150
4,50	185	125	4,50	235	160
5,00	195	135	5,00	245	170
5,50	205	140	5,50	260	180
6,00	205	140	6,00	260	180
6,50	215	150	6,50	275	190
7,00	225	155	7,00	290	200
7,50	225	155	7,50	290	200
8,00	240	165	8,00	305	210
8,50	240	165	8,50	-	-
9,00	250	175	9,00	320	220
9,50	250	175	9,50	320	220
10,00	265	185	10,00	340	235
10,50	265	185	10,50	340	235
11,00	280	195	11,00	365	250
11,50	280	195	11,50	365	250
12,00	295	205	12,00	375	260
12,50	295	205	12,50	375	260
13,00	295	205	13,00	375	260

**Hand Tap Sets
3-pcs. metric**



M	Pitch	Drilling size mm
M 3	0,50	2,50
M 4	0,70	3,30
M 5	0,80	4,20
M 6	1,00	5,00
M 8	1,25	6,80
M 10	1,50	8,50
M 12	1,75	10,20
M 14	2,00	12,00
M 16	2,00	14,00
M 18	2,50	15,50
M 20	2,50	17,50
M 22	2,50	19,50
M 24	3,00	21,00

Dies metric



M	Pitch
M 3	0,50
M 4	0,70
M 5	0,80
M 6	1,00
M 8	1,25
M 10	1,50
M 12	1,75
M 14	2,00
M 16	2,00
M 18	2,50
M 20	2,50
M 22	2,50
M 24	3,00

**Machine Taps HSS-E
Form C / 35° Cobalt**



M	Pitch	Drilling size mm
DIN 371		
M 3	0,50	2,50
M 4	0,70	3,30
M 5	0,80	4,20
M 6	1,00	5,00
M 8	1,25	6,80
M 10	1,50	8,50
DIN 376		
M 12	1,75	10,20
M 14	2,00	12,00
M 16	2,00	14,00
M 18	2,50	15,50
M 20	2,50	17,50
M 22	2,50	19,50
M 24	3,00	21,00

**Hand Tap Sets
2-pcs. BSP**



G/BSP	Pitch	Drilling size mm	€
G 1/8	28	8,80	19,41
G 1/4	19	11,80	24,30
G 3/8	19	15,25	29,46
G 1/2	14	19,00	36,38
G 5/8	14	21,00	51,74
G 3/4	14	24,50	59,30
G 1	11	30,75	85,26

Dies BSP



G/BSP	Pitch
G 1/8	28
G 1/4	19
G 3/8	19
G 1/2	14
G 3/4	14

**Tap Wrenches
with ratchet**



Size	L mm	M
short version		
1	85	M 3 - 10
2	100	M 5 - 12
long version		
10	250	M 3 - 10
20	300	M 5 - 12

**Hand Tap Sets
2-pcs. metric fine**



MF	Pitch	Drilling size mm
MF 3	0,35	2,65
MF 4	0,35	3,65
MF 4	0,50	3,50
MF 5	0,50	4,50
MF 6	0,75	5,20
MF 8	0,75	7,20
MF 8	1,00	7,00
MF 10	1,00	9,00
MF 10	1,25	8,80
MF 12	1,00	11,00
MF 12	1,25	10,80
MF 12	1,50	10,50
MF 14	1,00	13,00
MF 14	1,25	12,80
MF 14	1,50	12,50
MF 16	1,00	15,00
MF 16	1,50	14,50
MF 18	1,50	16,50
MF 20	1,50	18,50
MF 22	1,50	20,50
MF 24	1,50	22,50

Dies metric fine



MF	Pitch
MF 6	0,75
MF 8	0,75
MF 8	1,00
MF 10	1,00
MF 10	1,25
MF 12	1,00
MF 12	1,25
MF 12	1,50
MF 14	1,25
MF 14	1,50
MF 16	1,50
MF 18	1,50
MF 20	1,50
MF 22	1,50
MF 24	1,50

**Adjustable Tap Wrenches
DIN 1814**



Size	M - MF
2	M 4 - 12
3	M 5 - 20
4	M 11 - 27
5	M 13 - 32

Die Stocks DIN 225



Size	Measure
1	20 x 5
2	20 x 7
3	25 x 9
4	30 x 11
5b	38 x 14
6b	45 x 18

**Left Hand Tap Sets
3-pcs. metric**







M	Pitch	Drilling size mm
M 3	0,50	2,50
M 4	0,70	3,30
M 5	0,80	4,20
M 6	1,00	5,00
M 8	1,25	6,80
M 10	1,50	8,50
M 12	1,75	10,20

**Combined Machine Taps
HSS-E (Co 5)**



M	Pitch	Drilling size mm
M 3	0,50	2,50
M 4	0,70	3,30
M 5	0,80	4,20
M 6	1,00	5,00
M 8	1,25	6,80
M 10	1,50	8,50
M 12	1,75	10,20

Countersinks DIN 335 Type C 90°

Ø mm	Ø mm Point	Ø mm Shank	DIN 74 BF	 HSS-ground	 HSS-ground TiN-coated	 HSS-ground TiALN-coated	 HSS-cobalt
6,3	1,5	5	M 3	✓	✓	✓	✓
8,3	2,0	6	M 4	✓	✓	✓	✓
10,4	2,5	6	M 5	✓	✓	✓	✓
12,4	2,8	8	M 6	✓	✓	✓	✓
16,5	3,2	10	M 8	✓	✓	✓	✓
20,5	3,5	10	M 10	✓	✓	✓	✓
25,0	3,8	10	M 12	✓	✓	✓	✓
28,0	4,0	12	M 14	✓	✓	✓	✓
31,0	4,2	12	M 16	✓	✓	✓	✗
40,0	4,2	13	M 20	✓	✗	✗	✗

Bi-Metal Hole Saws HSS VARIO-Toothing



Ø mm	inch	Ø mm	inch
14	9/16	57	2.1/4
16	5/8	59	2.5/16
17	11/16	60	2.3/8
19	3/4	64	2.1/2
20	-	65	2.9/16
21	13/16	67	2.5/8
22	7/8	68	2.11/16
24	15/16	70	2.3/4
25	1	73	2.7/8
27	11/16	75	-
29	11/8	76	3
30	1.3/16	79	3.1/8
32	1.1/4	83	3.1/4
33	1.5/16	86	3.3/8
35	1.3/8	89	3.1/2
37	1.7/16	92	3.5/8
38	1.1/2	95	3.3/4
40	1.9/16	98	3.7/8
41	1.5/8	102	4
43	1.11/16	105	4.1/8
44	1.3/4	108	4.1/4
45	-	111	4.3/8
46	1.13/16	114	4.1/2
48	1.7/8	121	4.3/4
50	-	127	5
51	2	133	5.1/4
52	2.1/16	140	5.1/2
54	2.1/8	152	6
55	-	168	6.5/8
56	-	210	8.9/32

Bi-Metal Hole Saws HSS-E (Co8) 8% Cobalt, VARIO-Toothing



Ø mm	inch	Ø mm	inch
16	5/8	57	2 1/4
19	3/4	60	2 3/8
20	-	64	2 1/2
22	7/8	65	2 9/16
25	1	68	2 11/16
27	-	73	2 7/8
29	-	76	3
30	1 3/16	83	3 1/4
32	1 1/4	86	3 3/8
35	1 3/8	89	3 1/2
38	1 1/2	92	3 5/8
40	1 9/16	98	3 7/8
44	1 3/4	102	4
48	1 7/8	108	4 1/4
51	2	127	5
54	2 1/8		

Arbors for Hole Saws, hex-shank



Type	Shank	Ø mm
AS 11	SW 9,5	14-30
AS 3	SW 11	32-210

Pilot-drills HSS for Hole Saws



Type	Ø x L mm
ZB 2	6,35 x 83

Jigsaw Blade for Wood



For soft wood (5-50 mm), chipboards.

Fast and rough cut!

BOSCH-Ref. T 144 D

1961-U PK5 toothed length 75 mm

Jigsaw Blade for Metal



For thin sheet metal. Straight cutting in metal and non-ferrous metals up to 2 mm.

BOSCH-Ref. T 118 A

1964-12 PK5 toothed length 55 mm

Sabre Saw Blade for Wood



For all wood types and plastics.

BOSCH-Ref. S 644 D

1970-6 PK5 toothed length 130 mm

BOSCH-Ref. S 1344 D

1970-6EL PK5 toothed length 280 mm

Sabre Saw Blade for Metal

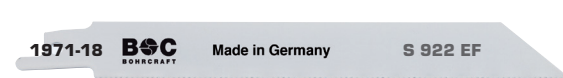

For steel and stainless steel from 1,5 - 2,5 mm thickness.

BOSCH-Ref. S 922 EF

1971-18 PK5 toothed length 130 mm



For steel and stainless steel from 2,5 - 3,0 mm thickness and non-ferrous materials.

BOSCH-Ref. S 1122 BF

1971-14L PK5 toothed length 180 mm

SDS-max Chisel



size + type	L mm
25 mm flat chisel	280
25 mm flat chisel	400
50 mm spade chisel	400
80 mm spade chisel	400
26 mm hollow chisel	300
50 mm tile chisel	300

Masonry Drill Bits TCT



Ø mm	Ø inch	L mm
3,0	1/8	70
4,0	5/32	75
5,0	3/16	85
5,5	7/32	85
6,0	15/64	100
6,5	1/4	100
7,0	9/32	100
8,0	5/16	120
10,0	3/8	120
11,0	7/16	150
12,0	15/32	150
13,0	1/2	150
14,0	9/16	150
16,0	5/8	160

Hammer Drill Bits SDS-plus



Ø mm	L mm	L2 mm	Ø mm	L mm	L2 mm
4,0	110	50	14,0	160	100
5,0	110	50	14,0	210	150
5,0	160	100	14,0	260	200
5,5	110	50	14,0	310	250
5,5	160	100	14,0	460	400
6,0	110	50	14,0	600	550
6,0	160	100	14,0	1000	950
6,0	210	150	15,0	160	100
6,0	260	200	15,0	260	200
6,5	110	50	16,0	160	100
6,5	160	100	16,0	210	150
6,5	210	150	16,0	300	250
6,5	260	200	16,0	450	400
7,0	160	100	16,0	600	550
8,0	110	50	16,0	1000	950
8,0	160	100	18,0	200	150
8,0	210	150	18,0	300	250
8,0	260	200	18,0	450	400
8,0	310	250	18,0	600	550
8,0	460	400	18,0	1000	950
10,0	110	50	20,0	200	150
10,0	160	100	20,0	300	250
10,0	210	150	20,0	450	400
10,0	260	200	20,0	600	550
10,0	310	250	20,0	1000	950
10,0	460	400	22,0	250	200
10,0	600	550	22,0	300	250
12,0	160	100	22,0	450	400
12,0	210	150	22,0	600	550
12,0	260	200	22,0	1000	950
12,0	310	250	24,0	250	200
12,0	460	400	24,0	450	400
12,0	600	550	25,0	450	400
12,0	1000	950	26,0	450	400

Auger Bits LEWIS, hex-shank



Ø mm	L mm	L mm
10,0	230	460
12,0	230	460
14,0	230	460
16,0	230	460
18,0	230	460
20,0	230	460
22,0	230	460
24,0	230	460
25,0	230	460
26,0	230	460
28,0	230	460
30,0	230	460
32,0	230	460

SDS-plus Rebar Drills with Solid Carbide Head



Ø mm	L mm	L2 mm
6,0	160	100
6,0	210	150
6,5	160	100
6,5	210	150
8,0	160	100
8,0	210	150
8,0	310	250
8,0	460	400
10,0	160	100
10,0	210	150
10,0	310	250
10,0	460	400

Ø mm	L mm	L2 mm
12,0	160	100
12,0	210	150
12,0	310	250
12,0	450	400
14,0	160	100
14,0	210	150
14,0	310	250
14,0	450	400
16,0	160	100
16,0	210	150
16,0	450	400

Key Type Drill Chuck



Delivery with key

mm Capacity	Mount	Key	Part-No.
1,5 - 13	1/2" x 20 UNF	S2	P978700

Only key

Size	mm Pin	L mm	Part-No.
S2	6,0	80	

Key Type Drill Chuck „PRO“

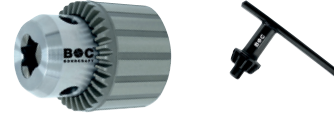

Delivery with key

mm Capacity	Mount	Key	Part-No.
2,0 - 13	1/2" x 20 UNF	S8	P979405

Keyless Drill Chuck „Auto-Lock“



mm Capacity	Mount	Part-No.
1,5 - 13	1/2" x 20 UNF	P977550

Keyless Drill Chuck „Auto-Lock“



mm Capacity	Mount	Part-No.
1,5 - 13	1/2" x 20 UNF	79406

Quick-Action Drill Chuck „PRO“



mm Capacity	Mount	mm Concentricity	Part-No.
1,0 - 13	B16	0,25	79407
1,0 - 16	B16	0,25	79408

Keyless Drill Chuck „Auto-Lock“



mm Capacity	Mount	Part-No.
1,0 - 13	1/2" x 20 UNF	76800

Above prices are subject to VAT.

Hand-Reamers DIN 206 Form B HSS

















Ø mm	L mm Overall	L mm Flute	Ø mm Shank	mm Square	Teeth
4,0	76	38	4	3,0	4
5,0	87	44	5	3,8	6
6,0	93	47	6	4,9	6
7,0	107	54	7	5,5	6
8,0	115	58	8	6,2	6
9,0	124	62	9	7,0	6
10,0	133	66	10	8,0	6
11,0	142	71	11	9,0	8
12,0	152	76	12	9,0	8
14,0	163	81	14	11,0	8
16,0	175	87	16	12,0	8
18,0	188	93	18	14,5	8
20,0	201	100	20	16,0	8
22,0	215	107	22	18,0	8
24,0	231	115	24	20,0	8
25,0	231	115	25	20,0	8
26,0	231	115	26	20,0	8
28,0	247	124	28	22,0	8
30,0	247	124	30	24,0	8

Machine-Reamers DIN 208 Form B HSS-E





Ø mm	L mm Overall	L mm Flute	Tapershank	Teeth
10,0	168	38	1	6
12,0	182	44	1	6
14,0	189	47	1	8
16,0	210	52	2	8
18,0	219	56	2	8
20,0	228	60	2	8
22,0	237	64	2	8
24,0	268	68	3	8
25,0	268	68	3	8
26,0	273	70	3	8
28,0	277	71	3	10
30,0	281	73	3	10







Carbide Burrs

Ø mm Head	Shape	Burr description	Z-KR (cross tothing)	Z-ALU (aluminium tothing)
6,0	A	Cylinder shape without endcut / 6,0 x 16-6 x 50		
8,0	A	Cylinder shape without endcut / 8,0 x 20-6 x 64		
10,0	A	Cylinder shape without endcut / 10,0 x 20-6 x 64		
12,0	A	Cylinder shape without endcut / 12,0 x 25-6 x 70		
6,0	B	Cylinder shape with endcut / 6,0 x 16-6 x 50		
8,0	B	Cylinder shape with endcut / 8,0 x 20-6 x 64		
10,0	B	Cylinder shape with endcut / 10,0 x 20-6 x 64		
12,0	B	Cylinder shape with endcut / 12,0 x 25-6 x 70		
6,0	C	Ball nosed cylinder shape / 6,0 x 16-6 x 50		
8,0	C	Ball nosed cylinder shape / 8,0 x 20-6 x 64		
10,0	C	Ball nosed cylinder shape / 10,0 x 20-6 x 64		
12,0	C	Ball nosed cylinder shape / 12,0 x 25-6 x 70		
16,0	C	Ball nosed cylinder shape / 16,0 x 25-6 x 70		
6,0	D	Ball shape / 6,0 x 5-6 x 50		
8,0	D	Ball shape / 8,0 x 6-6 x 52		
10,0	D	Ball shape / 10,0 x 9-6 x 54		
12,0	D	Ball shape / 12,0 x 10-6 x 56		
16,0	D	Ball shape / 16,0 x 14-6 x 59		
6,0	F	Ball nosed tree shape / 6,0 x 18-6 x 60		
10,0	F	Ball nosed tree shape / 10,0 x 20-6 x 64		
12,0	F	Ball nosed tree shape / 12,0 x 25-6 x 70		
6,0	G	Pointed tree shape / 6,0 x 16-6 x 50		
10,0	G	Pointed tree shape / 10,0 x 20-6 x 64		
12,0	G	Pointed tree shape / 12,0 x 25-6 x 70		
16,0	G	Pointed tree shape / 16,0 x 25-6 x 70		
8,0	H	Flame shape / 8,0 x 20-6 x 64		-
12,0	H	Flame shape / 12,0 x 32-6 x 77		
6,0	L	Ball nosed cone shape / 6,0 x 16-6 x 50		
10,0	L	Ball nosed cone shape / 10,0 x 25-6 x 72		
12,0	L	Ball nosed cone shape / 12,0 x 28-6 x 75		
16,0	L	Ball nosed cone shape / 16,0 x 33-6 x 78		

Long Carbide Burrs

Ø mm Head	Shape	Burr description	Z-KR (cross tothing)
6,0	B	Cylinder shape with endcut / 6,0 x 16-6 x 100	
8,0	B	Cylinder shape with endcut / 8,0 x 20-6 x 170	
10,0	B	Cylinder shape with endcut / 10,0 x 20-6 x 170	
12,0	B	Cylinder shape with endcut / 12,0 x 25-6 x 175	
6,0	C	Ball nosed cylinder shape / 6,0 x 16-6 x 100	
8,0	C	Ball nosed cylinder shape / 8,0 x 20-6 x 170	
10,0	C	Ball nosed cylinder shape / 10,0 x 20-6 x 170	
12,0	C	Ball nosed cylinder shape / 12,0 x 25-6 x 175	
8,0	D	Ball shape / 8,0 x 6-6 x 170	
10,0	D	Ball shape / 10,0 x 9-6 x 170	
12,0	D	Ball shape / 12,0 x 10-6 x 175	

Miniature Carbide Burrs, shank 3,0 mm

Ø mm Head	Shape	Burr description	Z-KR (cross tothing)
3,0	B	Cylinder shape with endcut / 3,0 x 13-3 x 38	
6,0	B	Cylinder shape with endcut / 6,0 x 13-3 x 48	
3,0	C	Ball nosed cylinder shape / 3,0 x 13-3 x 38	
6,0	C	Ball nosed cylinder shape / 6,0 x 13-3 x 48	
3,0	D	Ball shape / 3,0 x 2,5-3 x 38	
6,0	D	Ball shape / 6,0 x 5-3 x 40	
3,0	E	Oval shape / 3,0 x 6-3 x 38	
6,0	E	Oval shape / 6,0 x 10-3 x 45	
3,0	F	Ball nosed tree shape / 3,0 x 13-3 x 38	
6,0	F	Ball nosed tree shape / 6,0 x 10-3 x 45	
3,0	G	Pointed tree shape / 3,0 x 13-3 x 38	
6,0	G	Pointed tree shape / 6,0 x 13-3 x 48	
3,0	H	Flame shape / 3,0 x 6-3 x 38	
3,0	M	Cone shape / 3,0 x 11-3 x 38	
6,0	M	Cone shape / 6,0 x 13-3 x 48	

Taps, Split Dies + Die Nuts



(all taps are 3 piece set)

	UNC Tap	UNC Die	UNC Die Nut	UNF Tap	UNF Die	UNF Die Nut
3/16"	P2231	P1507O	P1508M	P2241	P1527B	P1527C
1/4"	P2232	P1508	P1508N	P2242	P1528	P1528N
5/16"	P2233	P1509	P1509N	P2243	P1530	P1530N
3/8"	P2234	P1510	P1510N	P2244	P1531	P1531N
7/16"	P2235	P1513	P1513N	P2245	P1535	P1535N
1/2"	P2236	P1514	P1514N	P2246	P1532	P1533
9/16"	P2236A	P1515	P1515N	P2247	P1537	P1538
5/8"	P2237	P1520	P1520N	P2248	P1534	P1533/1
3/4"	P2238	P1521	P1525D	P2249	P1540	P1541
7/8"	P2239	P1526	P1526A	P2250	P1542	P1543
1"	P2240	P1527	P1527A	P2251	P1545A	P1546



115mm 76Zi flap disc
 Available in grits 40/ 60/ 80
New Improved
 now 30% better performance

115mm LVZ flap disc

178mm LVZ flap disc
 Grits 40/ 60/ 80/ 120

Use LVZ flap discs where a perfect finish is required in stainless steel



Eolo Flap Disc



- A12398** 115mm 40g
- A1238A** 125mm 40g
- A1239** 180mm 40g

Eolo flap discs are best used when a lot of material needs to be removed quickly

Emery Rolls 50mm x 50mtr

- | | |
|-------------------|-------------------|
| A1907 36g | A1212 180g |
| A1908 60g | A1213 220g |
| A1909 80g | A1214 240g |
| A1910 100g | A1215 280g |
| A1911 120g | |



Rapid Scotch Polishing Disc 115mm



A1229G

Felt Polishing
Disc for Mirror
Finish 115mm

A1262

Fine
Green

A1263

V-Fine
Blue

A1260

Medium
Red

A1261

Course
Brown

PTX Polishing Wheels 100mm x 100mm



RSP58

A1511 Course
A1511A Medium
A1511B Fine
A1511C V-Fine

RSP56

A1500 Grit 40
A1501 Grit 60
A1502 Grit 80
A1503 Grit 120
A1504 Grit 180

RSP57

A1543 Grit 60 Course
A1544 Grit 80 Medium
A1545 Grit 120 Medium
A1546 Grit 180 Fine

Paint Stripping Disc



A1229I

115mm
DV121



165 x 25mm

Grit 40 A1221
Grit 60 A1221A
Grit 80 A1221B
Grit 120 A1221C
Grit 180 A1222

165 x 15mm

Grit 40 A1221D
Grit 60 A1221E
Grit 80 A1221F
Grit 120 A1221G

165 x 50mm

Grit 40 A1222A
Grit 60 A1223
Grit 80 A1224
Grit 100 A1225
Grit 120 A1226

TAF Blending Discs DUP-122 115mm



A1229D

Medium

A1229B

Course

A1229C

Fine

Flapwheels on Shaft

Flapwheels in Aluminium Oxide Cloth



Diameter mm	Width mm	Shaft mm	Packing	Max rpm
30	10	6	25	19000
30	15	6	25	19000
30	20	6	25	19000
40	15	6	25	15000
40	20	6	25	15000
50	20	6	25	12000
50	30	6	25	12000
60	15	6	25	9000
60	20	6	25	9000
60	30	6	25	9000
60	40	6	25	9000
80	30	6	25	6000
80	50	6	25	6000

Interleaved Flapwheels

Flapwheels on shaft for satin finishing



Diameter mm	Thickness s mm	Shaft mm	Grit			Item RGM19	
			120/AM	80/AM	60/AC	Unit of Sale	Max rpm
40	20	6	•	•	•	10	14000
60	30	6	•	•	•	10	9500
80	50	6	•	•	•	10	7000

Non-Woven Politaf Flapwheels

Diameter mm	Thickness mm	Shaft mm	Grit				Item RGP20	
			A/VF	A/F	A/m	A/C	Unit of Sale	Max rpm
40	20	6	•	•	•	•	10	14000
60	30	6	•	•	•	•	10	9500
80	50	6	•	•	•	•	10	7000



A1217
SCOTBRITE ROLL
115mm X 10 MTR



SCOTBRITE POLISHING MOP 150mm
A1236 COURSE
A1236A MEDIUM
A1236B FINE



SCOTBRITE PADS
A1227A MAROON
A1227B GREEN
A1227C GREY

TAF AND TYROLIT CUTTING AND GRINDING DISCS



Tyrolit 3 Star Steel Cutting

A2015 115 x 1mm
 A2556 230 x 1.9mm flat
 A2017 230mm DPC



Tyrolit 1 Star Cutting

A2606	4" DPC
A2607	4 1/2"
A2605	5"
A2608	7"
A2609	9"
A2610	12" 22mm bore
A2611	12" 25mm bore
A2610	12" 20mm bore
A2613	14" x 2.8mm for chop saw
A2613A	14" x 4mm for consaw
A2016D	100mm x 1mm flat
A2016A	115mm x 1mm
A2016B	125mm x 1.6mm
A2615A	230mm x 2mm



TAF Steel Cutting

A2650 115 x 1mm flat
 A2651 230 x 2mm flat
 A2654 350mm
 A2652 115mm DPC
 A2653 230mm DPC



Tyrolit Aluminium Cutting

A2558 115mm DPC
 A2657AA 125 x 1mm flat
 A2565 230mm DPC



Tyrolit Aluminium Grinding

A2557 115mm
 A2566 230mm



Tyrolit 1 Star Grinding

A2620 100mm
 A2621 115mm
 A2622 125mm
 A2623 178mm
 A2624 230mm



TAF STEEL GRINDING

A2655 115mm
 A2656 230mm



Tyrolit Stone Cutting

A2576 100mm
 A2577 115mm
 A2575 125mm
 A2579 230mm
 A2580 300mm 20mm Bore
 A2581 300mm 22mm Bore

BELTS FOR PORTABLE SANDERS



SIZES:
410 X 65mm
533 X 75mm
560 X 100mm
610 X 100mm

AVAILABLE IN GRITS:
40 60 80 100 120

BELTS FOR STATIONARY SANDERS



SIZES:
915 X 100mm
1220 X 100mm
2000 X 75mm
2000 X 150mm

AVAILABLE IN GRITS:
40 60 80 120

BELTS FOR PIPEWORK SANDERS



SIZES:
10 X 330mm
10 X 533mm
13 X 455mm
20 X 520mm
30 X 533mm
40 X 820mm

AVAILABLE IN GRITS:
60 80 120

SCOTBRITE BELTS FOR SURFACE CONDITIONING



SIZES:
13 X 457mm MEDIUM
13 X 457mm FINE
40 X 820mm MEDIUM
40 X 820mm FINE

DZ73 SANDING DISCS



A1860	115mm GRIT	24
A1861		36
A1862		50
A1863		60
A1864		80
A1870	180mm GRIT	24
A1871		36
A1872		50
A1873		60
A1874		80

CS78 SANDING DISCS VELCRO



150mm GRIT 60 80 120
180 220 320 400 500

AVAILABLE IN 6 HOLE DUST EXTRACTION OR NO HOLE-PLAIN

CR57 SANDING DISCS VELCRO



125mm GRIT 40 80 120 240
150mm GRIT 40 60 80 100 120

AVAILABLE IN 6 HOLE DUST EXTRACTION OR NO HOLE-PLAIN



Backing Pad
for DZ73

A1855 115mm
A1857 180mm



for Velcro

A1832
150mm



TYROLIT DIAMOND BLADES



Concrete Diamond Blade

A1432	115mm		
A1435	230mm		
A1436	300mm	20mm	1 STAR
A1436A	300mm	22mm	1 STAR
A1436B	300mm	20mm	2 STAR
A1437	350mm		
A1438	450mm		1 STAR
A1438A	450mm		2 STAR

Asphalt Blade

A1437	300mm	1 STAR
A1428	300mm	2 STAR
A1429	350mm	1 STAR
A1430	350mm	2 STAR
A1431	450mm	1 STAR

Granite Diamond Blade

A1406	300mm
-------	-------



Tile

A1469	115mm
A57662	180mm



Flap Wheel Assortment

PG35990	40 pce
PG35990A	20 pce



TI10113A

Spid Wire Brushes
Box of 24 pce.



PG49600

Wire Brush
Assortment
40 pce



PG39600

Mounted Point
Assortment
100 pce



BGS50840

Diamond Blade Pack 3 pce
115mm Segmented Rim,
Continuous Rim. Tile Rim

General Purpose Precision Grinding Wheels

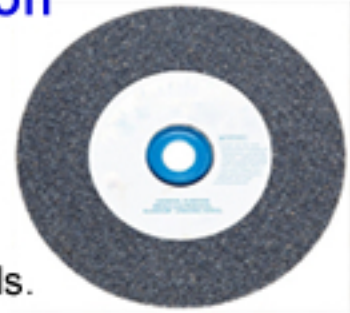

Carborundum wheels:

Hard and tough for working low alloy steels.
High stock removal for rough grinding

Item-No	Description	Grit	
A1034	150 x 20 x 31.75	10	A36
A1035	150 x 20 x 31.75	10	A60
A1023	150 x 22 x 31.75	10	A36
A1024	150 x 25 x 31.75	10	A60
A1102	200 x 20 x 31.75	10	A36
A1103	200 x 25 x 31.75	10	A60
A1104	200 x 25 x 31.75	10	A36
A1105	200 x 25 x 31.75	10	A60
A1124	250 x 25 x 31.75	10	A36
A1125	250 x 25 x 31.75	10	A60



Silicon Carbide Grinding Wheels For Tool Sharpening

A1231	150 x 20 x 31.75	C46
A1232	150 x 20 x 31.75	C60
A1233	200 x 25 x 31.75	C46
A1233A	200 x 25 x 31.75	C60



A741717
75mm x 1mm Disc

A1226B
Arbour For 75 x 1mm Discs
6mm Shank to Suit Pneumatic
Die Grinders

WIRE BRUSHES



PG Wire Brush
Stand ESPO



Wire Cup Brushes
M14 Crimped

PG48540 M14 x 75mm
PG48550 M14 x 100mm
PG48560 M14 x 120mm



Wire Cup Brushes
M14 Platted

PG48570 M14 x 65mm
PG48576 M14 x 100mm
PG48577 M14 x 120mm



Bevelled Crimped
Brush M14 x 90mm

PG46700



Bevelled Platted
Brush M14 x 115mm

PG46835



Platted Brush
20mm on
6mm Spindle

BGS8363



PG47700 13mm End Brush
on 6mm Spindle
PG47800 25mm End Brush
on 6mm Spindle



Wire Brushes for
Bench Grinders

PG48800 150mm
PG48900 200mm



Knotted Brush
115mm x 22mm Bore

BGS3985



Knotted Brush 75mm
on 6mm Shaft

BGS3982



Spindle Circular Brushes
on 6mm Shaft

PG46900 50mm
PG47000 70mm
PG47500 100mm



Cup Brushes
on 6mm Shaft
PG48000 50mm
PG48500 70mm

**Stainless Wire Cup Brushes
M14 Thread**



- A0108** M14 x 75mm
Crimped Brush
- A0109** M14 x 100mm
Crimped Brush

**STAINLESS STEEL
WIRE BRUSHES**

Spindle Mounted Brushes



- A0112** 50mm x 6mm
- A0113** 70mm x 6mm
- A0114** 100mm x 6mm

Cup Brush



- A0111**
50mm x 6mm

**Platted Brush for Weld
Removal**



- A0107** 115mm

**Stainless Steel Wire Brush
with Plastic Handle**



- TI10114**

**Stainless Steel Wire Brush
with Wooden Handle**



- W2571**

**AMBERSIL BRIGHT
COLD GALVANISE 400ML**



**CORROSION PROTECTION
WITH HIGH ZINC CONTENT
L1355**

**AMBERSIL SPATTER RELEASE
309ML**



**NON FLAMMABLE, SILICON BASED
WELD ANTI SPATTER
L1404**

**AMBERSIL
PENETRATING
OIL 400ML**



L1340

**AMBERSIL WHITE SPRAY
GREASE 400ML**



**MULTI PURPOSE WHITE
SPRAY GREASE
L1428A**

**AMBERSIL COPPER ANTI SEIZE
SPRAY 400ML AEROSOL**



400g TIN L1342

**AMBERSIL 40+
MAINTENANCE
SPRAY**



400ML L1340A

**AMBERSIL AMBERKLEN
SOLVENT DEGREASER**



**400ML
L1414**

**AMBERSIL TUF CUT SPRAY
DRILL / TAPPING FLUID**



**L1393 400ML
SPRAY**



**L1392 400ML
FOAM**

**AMBERSIL METAL
MARKERS**



**AVAILABLE IN:
RED, BLACK, GREEN, BLUE,
YELLOW, WHITE, ORANGE,
SILVER AND GOLD**



**AMBERSIL
AMBERGLIDE
PTFE SPRAY**

**400ML
L1334**



**AMBERSIL CONTACT
CLEANER**

**400ML
ELECTRICAL
MAINTENANCE
SPRAY**

L1415



**AMBERSIL RUST
FLASH**

**400ML
FREEZES SEIZED
COMPONENTS**

L1339



WEICON LOCK

AN 302-42

Threadlocking | drinking water approval

- ▶ medium viscosity
- ▶ medium strength
- ▶ disassembly with normal tools

▶ 50 ml
L2205



AN 302-70

Locking of threads and stud bolts | drinking water and DVGW approval

- ▶ medium viscosity
- ▶ high strength
- ▶ hard to disassemble

▶ 50 ml
L2204



AN 305-72

Pipe and flange sealing (with PTFE) | immediate sealing effect | drinking water and DVGW approval

- ▶ high viscosity
- ▶ medium strength
- ▶ disassembly with normal tools

▶ 50 ml
L2202



AN 306-60

Assembly of cylindrical parts for worn out bearing rings and bushings

- ▶ high viscosity
- ▶ high strength
- ▶ hard to disassemble

▶ 50 ml
L2085



Gasket Maker

Permanently elastic special sealant
WEICON Gasket Maker is a strong and permanently elastic special sealant that cures with air humidity and practically without shrinkage. Gasket Maker has a very good adhesion to steel, aluminium, glass, ceramic, and many other materials.

▶ 310 ml
L2198
red

Black-Seal

Extremely resistant against oil and grease
WEICON Black-Seal Adhesive and Sealant is black, high-temperature-resistant (+280°C/+536°F), free of solvents, strong, oil-resistant, grease-resistant, pressure-resistant, resistant to ageing and extremely elastic (breaking elongation of approx. 500%).

▶ 310 ml
L2178
Cartridge

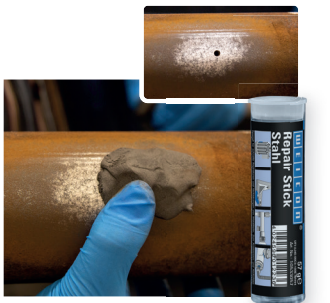

Epoxy Minute Adhesive

Viscous | self-levelling | fast-curing | very short pot life | transparent

▶ 24 ml
L2170

Repair Stick Steel



Fast cure | steel-filled | drinking water approval

▶ 57 g
L2171



VA 100



Cyanoacrylate Adhesive for rubber and plastics | medium viscosity | slightly longer curing

WEICON Contact VA 100 is a universal type for the bonding of metals, plastic and rubber, both to and among each other.

▶ 30 g
L2175

AL-T

High-temperature grease | long-term lubrication

WEICON AL-T high performance grease is a universally usable high-temperature grease for long-term lubrication. WEICON AL-T is suitable for rolling and sliding bearings, joints, levers, sliding guides, spindles, spline shafts and at all sliding speeds permitted for grease lubrication.

▶ 400 g
L2200



Seit 1947 produzieren wir bei WEICON Spezialprodukte für die Industrie. Zu unserem umfangreichen Produktprogramm zählen Spezialkleb- und Dichtstoffe, technische Sprays sowie Hochleistungsmontagepasten und Fette für alle Bereiche der Industrie - von der Produktion, Reparatur, Wartung bis hin zur Instandhaltung.



Brushable Zinc Coating

Provides active protection against corrosion for all metallic surfaces. (Colour matching hot-dip galvanized surfaces).

- ▶ 375 ml **L2181**
- ▶ 750 ml **L2182**



Zinc Spray bright grade

Colour matching hot-dip galvanizations. Double corrosion protection through zinc/ alu base coat and alkyd resin sealing. High resistance to salt and water. Result in salt spray test according to DIN EN ISO 9227 >550 hours.

- ▶ 400 ml **L2187**



Rust Loosener and Contact Spray

6-fold function: loosens rust, repels water, ensures contact, protects from corrosion, greases surfaces and maintains metal.

- ▶ 400 ml **L2183**



Copper Paste

Copper Paste is a protecting, separating and lubricating agent for highly stressed parts, used as assembly lubricant for threaded joints and sliding surfaces of all kinds.

- ▶ 500 g **L2184**



Crack Testing Agent



Cleaner

Material-neutral special cleaner for the dye penetrant test. Suitable for metals, many plastics, ceramic materials, glass etc. The suitability for plastic has to be tested in advance.

- ▶ 500 ml **L2190**



Penetrant

Red diffusion agent with excellent capillary action for the non-destructive material testing - washes off with solvent. Suitable for metals, many plastics, ceramic materials, glass etc. The suitability for plastic has to be tested in advance.

- ▶ 500 ml **L2191**



Developer

Colourfast special developer on solvent basis for dye penetrant tests. Suitable for metals, many plastics, ceramic materials, glass etc. The suitability for plastic has to be tested in advance.

- ▶ 500 ml **L2192**



**E1001 200mm
Combination Plier**



**E1006 200mm
Long Nose Plier**



Side Cutter



**E1008 140mm
E1009 160mm
E1010 180mm**

**E1016 224mm
Steel Fixers Plier**



**E1016B 240mm
Water Pump Plier**



Power Grip Plier



**E1003 180mm max.36mm
E1004 250mm max.46mm
E1004A 300mm max.60mm**



External 90°

Elora-No.	mm	
E8200	130	A01
E8201	130	A11
E8202	170	A21
E8203	210	A31
E8204	310	A41

Circlip Pliers



External Straight

Elora-No.	mm	
E8195	140	A0
E8197	140	A1
E8198	180	A2
E8187	220	A3
E8199	320	A4



Internal 90°

Elora-No.	mm	
E8191	130	J11
E8192	170	J21
E8193	210	J31
E8194	310	J41



Internal Straight

Elora-No.	mm	
E8186	140	J1
E8188	180	J2
E8189	220	J3
E8190	320	J4

**Fervi 0839/50
Dead Blow Mallet 50mm**



FV1115

Head	Weight	Quantity
50 mm	1,1 kg	5

**Fervi 0808/60 60mm
Mallet**



FV1117

Head	Quantity
60 mm	4* / 16

**Fervi C163 Plastic Tool Box
394 x 160 x 195mm**



FV1140

16", LOCKABLE , WITH 1 MOVABLE SHELF
AND 2 COMPARTMENTS FOR MOTION
WORK IN THE LID
Overall sizes
394 x 160 x 195h mm
Quantity
8* (* minimum order)

**Fervi C165 Plastic Tool Box
514 x 225 x 260mm**



FV1141

20", WITH 1 MOVABLE SHELF AND 2
COMPARTMENTS FOR MOTION
WORK IN THE LID
Overall sizes
514 x 225 x 260h mm
Quantity
6* (* minimum order)

**Fervi 0390 Tool Bag
400 x 225 x 250mm**

FV1142



WITH SHOULDER BELT MADE OF 1680
DENIER POLYESTER
Pockets
14
Dimensions
400 x 225 x 250h mm - 16" x 9" x 10" h
Weight
1,6 kg
Quantity
3

Fervi M020 Tap + Die Set M3-M12 + 1/8" BSP



P1627

Tap holder
M3 - 12
Round die-stock
25 x 9 mm

Taps

M3x0,5 - M4x0,7 - M5x0,8 - M6x1 - M7x1 -
M8x1,25 - M10x1,5 - M12x1,75 - 1/8" NPT27

Dies

M3x0,5 - M4x0,7 - M5x0,8 - M6x1 - M7x1 -
M8x1,25 - M10x1,5 - M12x1,75 - 1/8" NPT27

Quantity

10

Fervi M036 Tap + Die Set M3-M12 + Drills



P1628

Tap holder
M3 - 12
Round die-stock
25 x 9 mm
Screwdriver
6,5 x 50 mm

Taps

M3x0,5 - M4x0,7 - M5x0,8 -
M6x1
- M7x1 - M8x1,25 -
M10x1,5 - M12

Dies

M3x0,5 - M4x0,7 - M5x0,8 - M6x1 -
M7x1 - M8x1,25 - M10x1,5 - M12

Drills

2,5 - 3,3 - 4,2 - 5 - 6
- 6,8 - 8,5 - 10,3 mm

Quantity

5

Fervi P020 Electric Engraver 220V



FV1101

Vibrations
7200 / min
Power
230 V 50 Hz 13 W
Quantity
20

Fervi 0780 Claw Hammer 500g Fibreglass Handle



Weight
500 g
Quantity
6* / 36 (* minimum order)

FV1110

Fervi 0035 Safety Utility Knife



Standard blades
4
Trapezoidal blade
19 x 61 x 0,6 mm
Quantity
24* / 144 (* minimum order)

**Fervi 0755
12 Volt Diesel Pump
175W 40LPM**



Motor
DC 12 V, 175 W
Motor speed
4500 rpm
Pump capacity
40 l/min
Hydraulic head
2 m

Suction
4 m
Inlet thread
25 mm
Size
200 x 120 x 155 mm
Weight
3.8 kg
EAN Code
8012667284084

FV1050

**Fervi
0056/1 Chain Hoist
1 Ton 3Mtr**



Capacity
1000 kg
Lifting
3000mm

Weight
12 kg
EAN Code
8012667181819

FV1060

**Fervi 0070/C
Winch 500kg 10 Mtr Cable**



Max load
500 kg
Throat width
50 mm
Max ø wheel
133 mm
Min. ø wheel
40 mm

Cable size
ø 4,5 mm x 10 m
Base dimensions
140 x 90 mm
Quantity
6
EAN Code
8012667244873

FV1070

**Fervi 0056/2
Chain Hoist 2 Ton 3Mtr**



Capacity
2000 kg
Lifting
3000 mm
Weight
22 kg
EAN Code
8012667185022

FV1061

**Fervi 0070 Winch 500kg
Bare**



Max load
500 kg
Throat width
50 mm
Max ø wheel
133 mm

Min. ø wheel
40 mm
Base dimensions
140 x 90 mm
Quantity
6

FV1071

**Fervi 0590 Winch with
Brake 500kg**



Max load
450 kg
Throat width
49 mm
Max ø wheel
110 mm
Min. ø wheel
45 mm

**Overall dimensions
without handle**
170 x 150 x 125h mm
Weight
2,7 kg
Quantity
10

FV1072

**Fervi
0023 Bench Grinder
350W 150mm**



FV1010

Grinding wheel
2950 rpm - Ø 150 x 20 x 12,7 mm
GR36 - GR80
Single-phase motor
2950 rpm - 230 V 50 Hz 0,35 kW
Usage type
S2 - 10 min
EAN Code
8012667000288
Weight
7,8 kg

**Fervi
S023 Bench Grinder
400W 150mm**



FV1011

Grinding wheel
2950 rpm - Ø 150 x 20 x 16 mm GR36
Grinding wheel
2950 rpm - Ø 150 x 20 x 16 mm GR80
Single-phase motor
2950 rpm - 230 V 50 Hz 0,40 kW
Usage type
S2 - 10 min
EAN Code
8012667302559
Weight
8 kg

**Fervi 0552
Professional Bench Grinder
200mm 900W**



FV1015

Grinding wheel
2950 rpm - Ø 200 x 25 x 20 mm
GR36 - GR80
Single-phase motor
230V 50Hz 0,9 kW
Usage type
S2 - 10 min
Weight
27 kg
EAN Code
8012667204747

**Fervi 0556
Professional Combined Bench
Grinder with Long Arms**



FV1016

Brush
2950 rpm - Ø 200 x 25 x 20 mm
Grinding wheel
2950 rpm - Ø 200 x 25 x 20 mm GR36
Distance between wheels
510 mm
Single-phase motor
230 V 50 Hz 0,75 kW
Usage type
S2 - 10 min
Weight
22 kg
EAN Code
8012667247300

Flamme Bandsaw Blades Made in Germany



1638 x 13	18TPI
2360 x 20	6/10-10/14
2460 x 27	6/10-10/14
2480 x 27	6/10-10/14
2700 x 27	6/10-10/14
2720 x 27	6/10-10/14
2750 x 27	6/10-10/14
3035 x 27	6/10
3180 x 27	4/6-6/10
3345 x 27	6/10-10/14
3430 x 27	6/10-10/14
3660 x 27	6/10
3810 x 27	6/10-10/14
5450 x 27	4/6

"Evolution" Type TCT Blade



E4158 355mmx2.4 x 25-6 66T

Hacksaw Blade 300mm 18/24/32 TPI



BGS2069 Junior Hacksaw
Blades

Power Hacksaw Blade

300mm
350mm
400mm
450mm

"Tomas" Cold Type Blades



E4155A 250mm x 2 x 32-2007

E4156 300mm x 2-5x32-2207

GF Saw Blade



E4155 63mm x 1.6x 16-64T

EP Soluble Cutting Fluid



L1013 5Ltr
L1014 25Ltr

Tapping/ Drilling



L1200 Fluid

L1201 Compound

Citri Cleanse Handcleaner



L1095 4.5 Ltr

L1238 The Works
Galvanising
Spray 400ml



L1210 The Works
Anti-Spatter 300ml
L1215 The Works
Penetrating Oil 300ml



TC1

Overall Length A
 Overall Width B
 Overall Height C
 Overall Base Length D

90mm
 100mm
 50mm
 64mm



TC2

165mm
 100mm
 75mm
 148mm

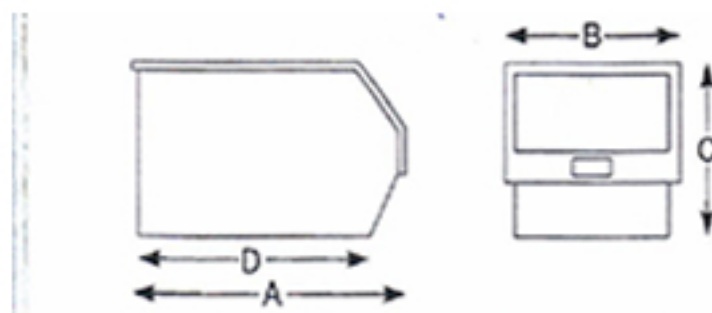

TC3

Overall Length A
 Overall Width B
 Overall Height C
 Overall Base Length D

240mm
 150mm
 132mm
 200mm



TC4

350mm
 205mm
 132mm
 300mm

NYLON CASTORS WITH PLATE FITTING



WHEEL	CAPACITY	FIXED	SWIVEL	BRAKED
50mm	50KG	C1010	C1011	C1012
80mm	60KG	C1015	C1016	C1017
100mm	150KG	C1020	C1021	C1022
125mm	180KG	C1025	C1026	C1027
150mm	300KG	C1030	C1031	C1032
200mm	300KG	C1036	C1037	C1038

RUBBER CASTORS, STEEL CENTRE, PLATE FIXING



WHEEL	CAPACITY	FIXED	SWIVEL	BRAKED
50mm	40KG	C1050	C1051	C1052
80mm	60KG	C1055	C1056	C1057
100mm	70KG	C1060	C1061	C1062
125mm	110KG	C1065	C1066	C1067
150mm	150KG	C1071	C1072	C1073
200mm	150KG	C1076	C1077	C1078

HEAVY DUTY CASTORS CAST CENTRE, POLYURETHANE TYRE, PLATE FIXING



WHEEL	CAPACITY	FIXED	SWIVEL	BRAKED
100mm	250KG	C1348	C1349	C1347
150mm	300KG	C1351	C1350	C1352

RUBBER TYRED WHEEL WITH PLASTIC CENTRE



C1251	150mm	20mm BORE
C1252	200mm	20mm BORE
C1253	200mm	25mm BORE

RUBBER TYRED WHEEL WITH STEEL CENTRE



C1250	150mm	20mm BORE
C1254	200mm	20mm BORE
C1255	250mm	25mm BORE
C1256	280mm	25mm BORE

PNEUMATIC WHEELS 260mm



C1260	260mm	20mm BORE
C1261	260mm	25mm BORE
C1262	260mm	20mm BORE WITH BEARING
C1263	260mm	25mm BORE WITH BEARING

STEEL CENTRE



C1267	260mm	16mm BORE
-------	-------	-----------

LIFTING AND LOAD BINDING EQUIPMENT

LOAD BINDING STRAPS



T1763	25mm 5 MTR 1 Ton Cap
T1763A	38mm 5 MTR 2 Ton Cap
T1761	50mm 8 MTR 5 Ton Cap
T1762	50mm 10MTR 5 Ton Cap

LIFTING EYES



**MALE
THREAD**

8mm	T1106
10mm	T1107
12mm	T1108
14mm	T1109
16mm	T1110
18mm	T1111
20mm	T1112
24mm	T1113
30mm	T1114



**FEMALE
THREAD**

T1106A
T1107A
T1108A
T1109A
T1110A
T1111A
T1112A
T1113A
T1114A

LIFTING SLINGS



Purple	1 Tonne
Green	2 Tonne
Yellow	3 Tonne
Grey	4 Tonne
Red	5 Tonne
Brown	6 Tonne
Blue	8 Tonne

T1643	Lifting Sling 1Mtr 2 Ton
T1644	Lifting Sling 1.5Mtr 2 Ton
T1645	Lifting Sling 2Mtr 2 Ton
T1646	Lifting Sling 2Mtr 1 Ton
T1647	Lifting Sling 3Mtr 1 Ton
T1648	Lifting Sling 3Mtr 2 Ton
T1649	Lifting Sling 4Mtr 2 Ton
T1650	Lifting Sling 3Mtr 3 Ton
T1651	Lifting Sling 4Mtr 3 Ton
T1651A	Lifting Sling 5Mtr 3 Ton
T1652	Lifting Sling 3Mtr 4 Ton
T1652A	Lifting Sling 4Mtr 4 Ton
T1652B	Lifting Sling 3Mtr 5 Ton

SHACKLES



T1669	1 Ton
T1670	2 Ton
T1671	3 Ton
T1672	4 Ton
T1673	6.5 Ton
T1674	8.5 Ton
T1675	9.5 Ton
T1676	12 Ton

CHAIN BLOCKS



SCB500	500kg 3 Mtr Chain
SCB1000	1000kg 3 Mtr Chain
SCB1000A	1000kg 6 Mtr Chain

LEVER HOISTS



SLH500	500kg 1.5 Mtr Chain
SLH750	750kg 1.5 Mtr Chain
SLH1000	1000kg 1.5 Mtr Chain

BEAM TROLLEY



T1770
1000 KG

BEAM CLAMP



T1770A
1000 KG

FZA VICES MADE IN ITALY

FZA Eurostahl All Steel Vices with Pipe Jaw



	Jaw Width	Max Jaw Opening	
E1500	110mm	120mm	7 KG
E1501	150mm	155mm	15.5 KG

FZA Mondial G Cast Steel Vice with Pipe Jaw



	Jaw Width	Max Jaw Opening	
E1503	150mm	200mm	17 KG
E1504	175mm	220mm	26 KG

FZA Special Cast Iron Vice



E1505 150mm 220mm 25

Heavy Duty Drill Press Vices



V9240 150mm 150mm

SEALEY DPV6

Aluminium Magnetic Jaw Set



BGS3045 150MM

Aluminium Jaw Sets in Wallet 4 PCE



BGS8442 100MM
 BGS8442-1 125MM
 BGS8442-2 150MM

1 SET PROFILE JAWS FOR CLAMPING
 THREADED ROD ETC
 1 SET TRANSVERSE PROFILE
 1 SET PLASTIC JAWS
 1 SET RUBBER JAWS



Bar Clamp

	Length	Reach	
E2852	250mm x	120mm	35 x 8 Bar
E2853	300mm x	120mm	35 x 8 Bar
E2830	350mm x	140mm	40 x 10 Bar
E2831	500mm x	140mm	40 x 10 Bar
E2832	600mm x	140mm	40 x 10 Bar
E2833	800mm x	140mm	40 x 10 Bar
E2834	1000mm x	140mm	40 x 10 Bar
E2834A	1500mm x	140mm	40 x 10 Bar
E2834B	2000mm x	140mm	40 x 10 Bar



Ratchet Bar Clamp



E2835 300mm x 107mm
35 x 8

Earth Clamp

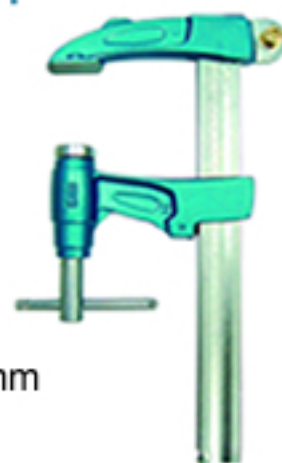

E2839 250mm

QUICK CLAMPS



E2856 150mm
E2857 300mm
E2858 450mm
E2859 600mm

URKO LIGHT DUTY CLAMPS



E2840 120mm 8 x
18mm Bar
E2841 150mm 8 x
18mm Bar
E2842 200mm 8 x
18mm Bar
E2843 250mm 8 x
18mm Bar
E2844 300mm 8 x
18mm Bar



Deep Reach

Length / Reach

E2860 350mm x 220mm (40 x 10)

E2861 600mm x 220mm (40x 10)

Heavy Duty Deep Reach

Length / Reach

E2850 350mm x 350mm (45 x 12)

E2851 600mm x 350mm (45 x 12)

G CLAMP



E2819

100mm

E2820

150mm

E2821

200mm

URKO STRUT



E2870 650mm 1150mm 180kg

E2871 1010mm 1770mm 180kg

E2872 160mm 2900mm 180kg

E2873 1950mm 3650mm 50kg



Bench Grinders



BG150XLW/98

150mm Bench Grinder 370 WATT With One 150mm Grinding Wheel And One 150mm With Brush



BG150XL/98

150mm Bench Grinder 370 WATT With One Rough And One Smooth 150mm Grinding Stone



BG200

200mm Bench Grinder 600 WATT With One Rough And One Smooth 200mm Grinding Stone

Hammers



Copper Faced Hammer

SCFH02 1.75Lb
SCFH03 2.75Lb
SCFH04 4.30Lb



Copper Rawhide Hammer

SCRF15 1.5Lb
SCRF25 2.25Lb
SCRF35 3.50Lb



72027

Nylon Hammer With Replacable Heads 680g



AK399

Lazy Tongs Riveter Takes 2.4 To 6.4MM Rivets



HS102

Sealey HS102 hot air gun 2000 watt 50-600 C



SA314

Pneumatic Rivet Gun
takes 2.4mm to 6.4mm
Rivets



SA31

Pneumatic Rivet Gun
takes 2.4mm to 4.8mm
Rivets



S701

Gold Series Spray
Gun



SA77

Pneumatic Sander
150mm



HS102

Hot Air Gun 2000W
50-600 Degrees

CST998

Sack Truck



CST988

Sack Truck



IRWIN VICE GRIPS



Vice Grip

E2546 4WR 100mm

E2539 5WR 125mm



Curved Jaw

E2542 10CR 250mm



Long Nose

E2537 6LN 150mm

E2550A 9LN 225mm



Straight Jaw

E2541 10R 250mm



Curved Jaw

E2547 7CR 175mm



C Clamp

E2534 11SP 275mm



C Clamp

E2532 18SP 455mm



Sheet Metal

E2545 8R 200mm



Welding Clamp

E2544 9R 225mm



Chain Clamp

E2550 20R 225mm

Chucks and Keys



PG78300 1-10mm
3/8 x 24 UNF

PG78700 1-13mm
1/2X20 UNF

E2515 3-16mm B16

E2515 3-20mm JT3

Chucks Keys



PG79000 10mm

PG79200 13mm

PG79300 16mm

PG79400 19mm

Keyless Chucks



PG77400 1-10mm
3/8X24 UNF

PG77550 1-13mm
1/2X20 UNF

Pump for Drill



PG89000

TEK Screw Driver



PG45210

8MM Magnetic

SDS Adaptor



PG78900

1/2 UNF

BGS Drill Adaptor Set 3 PCE



BGS8204

1/4" 3/8" 1/2"

Umeta 75PK Grease Gun



E9660

Grease Gun



E9660B

For Fuchs Type Screw
in Grease Cartridges

brennenstuhl®



B2006
KL250AF Headlight
250 Lumens



B2005
TL100F Slim Battery Torch
100 Lumens



B2007
TL600AF Rechargeable
630 Lumens

Cable Reels



B2003A 220 Volt 13 Amp 25 Mtr

B2003B 40 Mtr



B2002 110 Volt 16 Amp 25 Mtr

B2001 40 Mtr



B2003 220 Volt 16 Amp 25 Mtr

B2004 40 Mtr



BGS4235

7 Drawer Tool Chest



- heavy duty workshop finish
- stable sheet steel construction
- powder-coated body, particularly resistant to scratches
- heavy-duty, ball-bearing castors, including 2 lockable swivel castors
- with side handle for easy manoeuvring
- lockable with a central lock
- continuous handle strips
- 7 smooth-running drawers with ball-bearing slides:
- 1st to 5th drawer capacity up to 20 kg (each drawer)
- 6th to 7th drawer capacity up to 25 kg (each drawer)
- upper plate with rubber cover, capacity up to 50 kg

7 Drawer Tool Chest With 3 Tool Modules Totalling 263 Tools

- 1 workshop trolley | 7 drawers | empty
- 1 tool tray 3/3 socket set | 192 pcs.
- 1 tool tray 3/3 hammer, pliers, screwdriver set | 36 pcs.
- 1 tool tray 3/3 open end, combination, double ring spanners | 35 pcs.

BGS6062



7 Drawer Tool Chest With 5 Tool Modules Totalling 246 Tools



- 1 workshop trolley | 7 drawers | empty
- 1 tool tray 3/3 pliers, pin punch set, hammer | 17 pcs.
- 1 tool tray 3/3 combination spanners and E-Type spanners assortment | 22 pcs.
- 1 tool tray 3/3 screwdriver set | 23 pcs.
- 1 tool tray 3/3 socket set | 80 pcs.
- 1 tool tray 3/3 bit and bit socket | 104 pcs.

BGS6060



Loose Combination Spanner

Combi MM

BGS30554	4mm
BGS30553	4.5mm
BGS30552	5mm
BGS30556	6mm
BGS30557	7mm
BGS30558	8mm
BGS30559	9mm
BGS30560	10mm
BGS30561	11mm
BGS30562	12mm
BGS30563	13mm
BGS30564	14mm
BGS30565	15mm
BGS30566	16mm
BGS30567	17mm
BGS30568	18mm
BGS30569	19mm
BGS30570	20mm
BGS30571	21mm
BGS30572	22mm
BGS30523	23mm
BGS30574	24mm
BGS30525	25mm
BGS30526	26mm
BGS30577	27mm
BGS30578	30mm
BGS30579	32mm
BGS1084	34mm
BGS1086	36mm
BGS1088	38mm
BGS1091	41mm
BGS1096	46mm
BGS1100	50mm
BGS1185-55	55mm
BGS1185-57	57mm
BGS1185-60	60mm
BGS1185-65	65mm
BGS1185-70	70mm
BGS1185-75	75mm
BGS1185-85	85mm



Combi AF

BGS30188	1/4"
BGS30189	5/6"
BGS30190	3/8"
BGS30191	7/16"
BGS30192	1/2"
BGS30193	9/16"
BGS30194	5/8"
BGS30195	11/16"
BGS30196	3/4"
BGS30197	13/16"
BGS30198	7/8"
BGS30199	15/16"



BGS1228

Combination Spanner Set |
extra long | 6 - 19 mm |
14 pcs.



BGS1229

Combination Spanner
Set | extra long |
21 - 32 mm |
6 pcs.



BGS1216

Double Ring
Spanner Set |
S-Type |
10 x 11 - 18 x 19 mm |
5 pcs.



BGS30551

Combination Spanner
Set | 4 - 10 mm |
9 pcs.

**Ring Spanner Set
12 pce 6-32mm**



BGS1214

**Combination Spanner Set
25mm 1/4 - 1/4 AF**



BGS9473

**Ratchet Combination
Spanner Set
8-19mm 7 pce**



BGS1596

**Obstruction Ring
Spanner Set
5 pce 8-22mm**



BGS1217

**Ring Spanner Set
6 pce E6-E24**



BGS2268

**Box Spanner Set
9 pce 6-22mm**



BGS1218

**Combination Spanner Set
6 pce 34-50mm
Extra Long**



BGS1185

**Combination Spanner Set
6 pce 34-50mm
Extra Long**



BGS32400



Combination Spanner Set 8-19MM | 12 PCE



SIZES: 8-9-10-11-12-13-
14-15-16-17-18-19

BGS71021

Deep Hole Pipe Spanner Set 8-19mm | 12 Pce

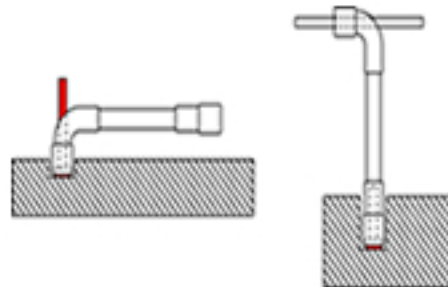

SIZES: 8-9-10-11-12-13-
14-15-16-17-18-19

BGS70186

Socket Set, 114 Hex | Extra Long 5.5-19mm | 15 Pce



SIZES: 5.5-6-7-8-9-10-11-
-12-13-14-15-16-
17-18-19

BGS70147

**Combanation Spanner
Set 8 pce 8-19mm**



BGS1193

**Combanation Spanner
Set 12 pce 6-22mm**



BGS1197

**Combanation Spanner
Set 25 pce 6-32mm**



BGS1196

**Combanation Spanner Set
12 pce 6-22 mm**



BGS30301

**Combanation Spanner Set
19 pce 8-32 mm**



BGS30500

**Double Ring Spanner
Set 8 pce 6-22 mm**



BGS30300

**Refridgeration Spanner
Set 6 pce 8-19 mm**



BGS1761

Ratchet Combination Spanner



BGS1578	8mm
BGS1579	9mm
BGS1580	10mm
BGS1581	11mm
BGS1582	12mm
BGS1583	13mm
BGS1584	14mm
BGS1585	15mm
BGS1586	16mm
BGS1587	17mm
BGS1588	18mm
BGS1589	19mm
BGS1591	21mm
BGS1592	22mm
BGS1694	24mm
BGS1697	27mm
BGS1700	30mm
BGS1702	32mm

Ratchet Podgers



BGS308	19 x 19mm
BGS309	17 x 21mm
BGS310	19 x 22mm
BGS311	19 x 24mm
BGS305	24 x 30mm
BGS306	27 x 32mm
BGS307	36 x 41mm

Crowfoot Spanner Sets 13 pce 1/2 Dr

BGS1757



20/21/22/23/24/25/
26/27/28/30/32mm

3/4 Set 8 pce



BGS1759

1/2" Dr Crowfoot Spanners

20mm	26mm
21mm	27mm
22mm	28mm
23mm	29mm
24mm	30mm
25mm	32mm

Adjustable Ratchet Combination Spanner



BGS1558	8mm
BGS1559	9mm
BGS1560	10mm
BGS1561	11mm
BGS1562	12mm
BGS1563	13mm
BGS1564	14mm
BGS1565	15mm
BGS1566	16mm
BGS1567	17mm
BGS1568	18mm
BGS1569	19mm



BGS Slogging Ring Wrenches

Part Number	Size
BGS35124	24mm
BGS35127	27mm
BGS35130	30mm
BGS35132	32mm
BGS35134	34mm
BGS35136	36mm
BGS35138	38mm
BGS35141	41mm
BGS35146	46mm
BGS35150	50mm
BGS35155	55mm
BGS35160	60mm
BGS35165	65mm
BGS35170	70mm
BGS35175	75mm
BGS35180	80mm



BGS Slogging Open End Wrenches



Part Number	Size
BGS35230	30mm
BGS35232	32mm
BGS35236	36mm
BGS35241	41mm
BGS35246	46mm
BGS35250	50mm
BGS35255	55mm
BGS35260	60mm
BGS35265	65mm
BGS35270	70mm
BGS35275	75mm
BGS35280	80mm
BGS35290	90mm
BGS35295	95mm



C Hook Wrench

BGS73210	16-20mm
BGS73211	25-28mm
BGS73212	30-32mm
BGS73213	34-36mm
BGS73214	40-42mm
BGS73215	45-50mm
BGS73216	52-55mm
BGS73217	58-62mm
BGS73218	68-75mm
BGS73219	80-90mm
BGS73220	95-100mm
BGS73221	110-115mm
BGS73222	120-130mm
BGS73223	135-145mm
BGS73224	155-165mm
BGS73225	180-195mm
BGS73226	205-220mm



Pin Hook Wrench

BGS74210	16-18mm
BGS74209	20-22mm
BGS74211	25-28mm
BGS74212	30-32mm
BGS74213	34-36mm
BGS74214	40-42mm
BGS74215	45-50mm
BGS74216	52-55mm
BGS74217	58-62mm
BGS74218	68-75mm
BGS74219	80-90mm
BGS74220	95-100mm
BGS74221	110-115mm
BGS74222	120-130mm
BGS74223	135-145mm
BGS74224	155-165mm
BGS74225	180-195mm
BGS74226	205-220mm

Adjustable C Hook Wrench



BGS73227	15-35mm
BGS73228	35-50mm
BGS73229	50-80mm
BGS73230	80-120mm
BGS73231	120-180mm

Adjustable Pin Hook Wrench



BGS74227	15-35mm
BGS74228	35-50mm
BGS74229	50-80mm
BGS74230	80-120mm
BGS74231	120-180mm



Adjustable C Hook Wrench Set 8 pce 35-120mm

BGS8542

35-60 / 60-90 / 90-120



1/4" Dr. Short	
MM	BGS-No.
3.5	BGS2473
4	BGS2474
4.5	BGS2475
5	BGS2476
5.5	BGS2477
6	BGS2478
7	BGS2479
8	BGS2480
9	BGS2481
10	BGS2482
11	BGS2483
12	BGS2484
13	BGS2485
14	BGS2486



3/8" Dr. Short	
MM	BGS No.
10	BGS10610
11	BGS10611
12	BGS10612
13	BGS10613
14	BGS10614
15	BGS10615
16	BGS10616
17	BGS10617
18	BGS10618
19	BGS10619



3/8" Dr. Long	
MM	BGS No.
8	BGS10528
10	BGS10530
11	BGS10531
12	BGS10532
13	BGS10533
14	BGS10534
15	BGS10535
16	BGS10536
17	BGS10537
18	BGS10538
19	BGS10539



1/4" Dr. Long	
MM	BGS No.
4	BGS10504
5	BGS10505
5.5	BGS10503
6	BGS10506
7	BGS10507
8	BGS10508
9	BGS10509
10	BGS10510
11	BGS10511
12	BGS10512
13	BGS10513
14	BGS10514

Sling Tee Bar

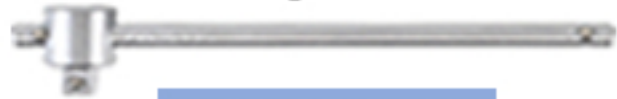

BGS No.	Content
BGS276	1/4" T-Bar
BGS277	3/8" T-Bar
BGS273	1/2" T-Bar
BGS263	3/4" T-Bar
BGS375	1" T-Bar

Breaker Bar



BGS No.	Content
BGS265	280mm - 1/2"
BGS267	610mm - 1/2"
BGS283	630mm - 3/4"
BGS376	1000mm - 1"



Sockets



1/2" Dr. Short

MM	BGS No.
8	BGS10628
9	BGS10629
10	BGS10630
11	BGS10631
12	BGS10632
13	BGS10633
14	BGS10634
15	BGS10635
16	BGS10636
17	BGS10637

1/2" Dr. Short

MM	BGS No.
18	BGS10638
19	BGS10639
20	BGS10640
21	BGS10641
22	BGS10642
24	BGS10644
27	BGS10645
30	BGS10646
32	BGS10647
34	BGS10648
36	BGS10649



3/4" Dr. Short

MM	BGS No.
19	BGS3419
21	BGS3421
22	BGS3422
24	BGS3424
27	BGS3427
30	BGS3430
32	BGS3432
33	BGS3433
34	BGS3434
35	BGS3435
36	BGS3436
38	BGS3438
41	BGS3441
42	BGS3442
44	BGS3444
46	BGS3446
50	BGS3450
55	BGS3455



1/2" Dr. Long

MM	BGS No.
10	BGS10680
13	BGS10681
15	BGS10682
16	BGS10683
17	BGS10684
18	BGS10685
19	BGS10686
22	BGS10687
24	BGS10688



1" Dr. Short

MM	BGS No.
36	BGS3736
41	BGS3741
46	BGS3746
50	BGS3750
55	BGS3755
60	BGS3760
65	BGS3765
70	BGS3770
75	BGS3775
80	BGS3780

Sliding Tee Bars

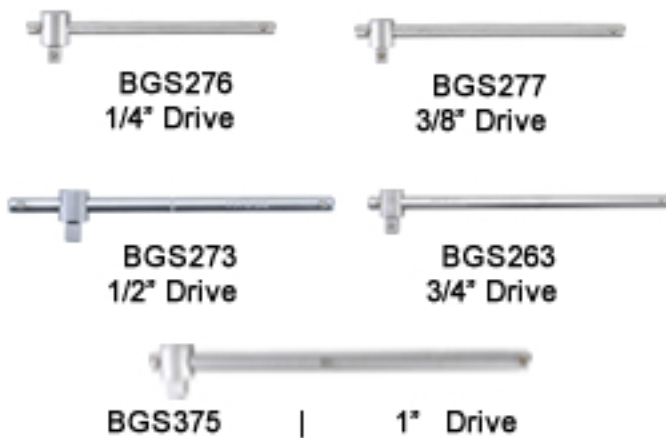

Swivel Head Bars



Extension Bars



Extension Bars 3/8" Drive



Extension Bars 3/4" Drive



Extension Bars 1/2" Drive



Wobble Extension Bars Set

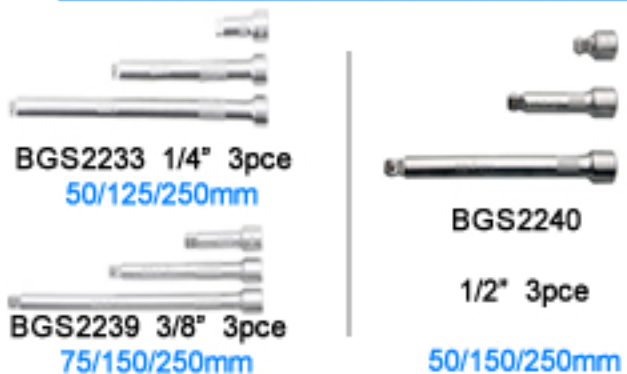

Extension Bars 1" Drive



Wobble Extension Bar Set 9pce



1/4 Dr 50mm 100mm 250mm
 3/8 Dr 75mm 150mm 250mm
 1/2 Dr 50mm 125mm 250mm

BGS2253

Adaptors



BGS271 1/4
 F x 3/8 M



BGS269 3/8
 F x 1/4 M



BGS280 3/8
 F x 1/2 M



BGS270 1/2
 F x 3/8 M



BGS272 1/2
 F x 3/4 M



BGS274 3/4
 F x 1/2 M

Universal Joints



BGS250 1/4 Dr



BGS299 3/8 Dr



BGS251 1/2 Dr

Socket Rails



BGS2316 1/4" DR
 7 Clips



BGS2317 3/8" DR
 15 Clips



BGS2318 1/2" DR
 7 Clips



BGS3460 3/4" DR
 12 Clips



BGS2540 1/2" DR
 15 Clips

Magnetic Socket Rail Holds 12 Sockets



BGS9342 1/4 Dr



BGS9343 3/8 Dr



BGS9344 1/2 Dr

Multi Socket Gear Lock



BGS8398

Hex 8-17mm
 Hex 5/16 - 11/16 AF
 E10 - E22

Adaptor Set 6pce



BGS199

1/4" Int x 3/8 Ext
 3/8" Int x 1/4 Ext
 3/8" Int x 1/2 Ext
 1/2" Int x 3/8 Ext
 1/2" Int x 3/4 Ext
 3/4" Int x 1/2 Ext

Angle Torque Gauge

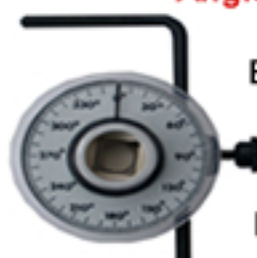

BGS3070 1/2" Dr

BGS3084 1/2" Dr



1/2" Drive. Hex Key Sockets



BGS No.	Size	Length
BGS4250	4mm	55mm
BGS4251	5mm	55mm
BGS4252	6mm	55mm
BGS4253	7mm	55mm
BGS4254	8mm	55mm
BGS4340	9mm	55mm
BGS4255	10mm	55mm
BGS4256	12mm	55mm
BGS4257	14mm	55mm

BGS No.	Size	Length
BGS4259	4mm	100mm
BGS4260	5mm	100mm
BGS4261	6mm	100mm
BGS4262	7mm	100mm
BGS4263	8mm	100mm
BGS4268	9mm	100mm
BGS4264	10mm	100mm
BGS4266	11mm	100mm
BGS4265	12mm	100mm

BGS No.	Size	Length
BGS5052-14	14mm	70mm
BGS5052-16	16mm	70mm
BGS5052-18	18mm	70mm
BGS4295	22mm	70mm
BGS No.	Size	Length
BGS5180-M10	10mm	140mm
BGS518M11	11mm	140mm
BGS4273	12mm	140mm
BGS5184-M13	13mm	140mm
BGS4274	14mm	140mm

1/2" Drive Female Torx Socket



BGS No.	Size
BGS6460	E10
BGS6461	E11
BGS6462	E12
BGS6464	E14
BGS6466	E16
BGS6418	E18
BGS6420	E20
BGS6422	E22
BGS6424	E24

1/2" Drive Torx Sockets



BGS No.	Size	Length
BGS4368	T15	55mm
BGS4369	T20	55mm
BGS4370	T25	55mm
BGS4367	T27	55mm
BGS4371	T30	55mm
BGS4372	T40	55mm
BGS4373	T45	55mm
BGS4374	T50	55mm
BGS4375	T55	55mm
BGS4378	T60	55mm
BGS4379	T70	55mm

BGS No.	Size	Length
BGS4468	T15	100mm
BGS4469	T20	100mm
BGS4470	T25	100mm
BGS4467	T27	100mm
BGS4471	T30	100mm
BGS4472	T40	100mm
BGS4473	T45	100mm
BGS4474	T50	100mm
BGS4475	T55	100mm
BGS4476	T60	100mm
BGS4477	T70	100mm

1/2" Dr. XZN Splined Sockets

BGS No.	Size	Length
BGS4356	M5	55mm
BGS4351	M6	55mm
BGS4355	M7	55mm
BGS4352	M8	55mm
BGS4349	M9	55mm
BGS4353	M10	55mm
BGS4354	M12	55mm
BGS4344	M14	55mm
BGS4346	M16	55mm
BGS518-M17	M17	55mm
BGS4347	M18	55mm



BGS No.	Size	Length
BGS4355	M5	100mm
BGS4360	M6	100mm
BGS4361	M8	100mm
BGS5184-M9	M9	100mm
BGS4362	M10	100mm
BGS4363	M12	100mm
BGS4364	M14	100mm

3/4" Drive Hex Keys 85mm Long



BGS5189-H14	14mm
BGS5189-H17	17mm
BGS5189-H19	19mm
BGS5189-H22	22mm

3/4" Drive Tox Keys 80mm Long



BGS5550	T50
BGS5555	T55
BGS5560	T60
BGS5565	T65
BGS5570	T70
BGS5580	T80
BGS5590	T90
BGS5600	T100

Impact 3/4" Drive Hex Keys 55mm Long



BGS5054-12	12mm
BGS5054-14	14mm
BGS5054-17	17mm
BGS5054-19	19mm
BGS5054-21	21mm
BGS5054-22	22mm
BGS5054-23	23mm
BGS5054-24	24mm

Impact 3/4" Drive Splined Keys 55mm Long



BGS5054-M16
BGS5054-M18
BGS5054-M24

**BGS Socket Set 1/4"
Drive 24 Pce**



BGS2140 PREMIUM

**BGS Socket Set 1/4"
Drive 53 Pce**



BGS2148 PREMIUM

BGS 1/4" Socket Set 52 PCE



1/4" Reversible Ratchet 1/4"
Sliding Tee Bar,
Universal Joint Spinner Handle,
Thumb Wheel Extension Bars 50+
100mm L Type Wrenches 1,
3-5mm 18 Bit Sockets
1/4" Dr 13 Sockets
1-14mm 6 Deep Sockets
8-14mm 7 E-Type Sockets E4-E11

BGS2147

**BGS 1/4" Socket
Set 28 Pce**



14"Dr, 28 PCE Sockets
5-13mm
PH1-PH2-Pz1-Pz2
Slot 4.5+6, Hex 3-4-5
Torx 10-15-20-25-27-
30-40

BGS2143

**Socket Set 1/4"
+ 1/2" 66 Pce**



BGS2248 PREMIUM

**BGS 1/4" Socket
Set 27 Pce**



14"Dr, 28 pce sockets
4-13mm TX bits
10-15-20-25-30 PH1-2
Slot 4-5, 5-7 Hex 3-4-5-6

BGS15105

Socket Sets



BGS2224

1/2" Dr, 27 pce
Sockets 8-32mm Spark
Plug Sockets 16-21mm



BGS2227

3/8" Dr, 26 pce 6-24mm



BGS15110

1/2" Dr, 19 pce 8-32mm



BGS2152

19 pce Gear Lock Set, 1/2"
the special gear lock profile provides
universal use of the hex, t-star, metric +
inch sizes.

8-9-10-11-12-13-14-15-16-17-18-19-
20-21-22-23-24-27-30-32mm also fits t-star
sockets E10-E12-E14-E16-E18-E20-E22-E24
SAE Sizes (5/16, 11/32, 3/8, 7/16, 15/32, 1/2,
9/16, 19/32, 5/8, 3/4, 25/32, 13/16, 7/8,
15/16, 1-3/16, 1-1/4) for hex sockets



BGS5100

Bit Socket / Socket Set 12.5 mm
(1/2") Dr E-Star / T-Star (for Torx)
19 pcs.



BGS5052

Bit Socket Set 12.5 mm (1/2")
Drive Internal Hexagon 5 - 22 mm
12 pcs.

**Metal workshop Tool Case | 3 Drawers | with
143 Tools**



BGS3318

Socket Set 3341
Screwdriver Set 3343
Plier Set 3344
Spanner Set 3342

**Socket Set Super Lock
| 6.3 mm (1/4") / 10 mm (3/8") 12.5 mm (1/2")
Drive | 192pcs.**

1/4" Sockets 4-4.5-5-5.5-6-7-8-9-10-11-12-13-14 1/4"
Deep Sockets 4-5-6-7-8-9-10 3/8"
Sockets 10-11-12-13-14-15-16-17-18-19 3/8"
Deep Sockets 10-11-12-13-14-15 1/2"
Sockets 10-11-12-13-14-15-16-17-18- 19-20-21-22-23-24-
27-30-32 1/2" Deep Sockets 16-17-18-19-22



BGS2292

Socket Set 117 pcs.



BGS9029

1/4" Dr Sockets 4-13mm
1/2" Dr Sockets 10-32mm
Combination Spanners 6-22mm
Pliers/Snips/Screwdrivers/Hammer



BGS1202

3/4" Dr. 20 Pce Socket Set
19, 21, 22, 23, 24, 26, 27, 30,
32, 34, 36, 38, 41, 46, 48, 50



BGS1207

3/4" Drive 21 Pce
19, 21, 22, 23, 24, 26,
27, 30, 32, 34, 36, 38, 41, 46, 48, 50

BGS1107

3/4" Dr. 21 Pce AF Set
7/8, 15/16, 1, 11/16, 1 1/8, 1 3/16, 1 1/4,
1 5/16, 1 3/8, 1 7/16, 1 1/2, 1 5/8, 1 3/4,
1 13/16, 1 7/8, 2"



BGS315 Reversible Ratchet 1/4"

BGS316 Reversible Ratchet 3/8"

BGS317 Reversible Ratchet 1/2"



BGS324

Reversible Ratchet, 380mm long,
72 tooth 1/2"



BGS232

2 Pce Ratchet with Lever and
"Quick Release Button" 3/4"

Swivel Head Ratchet 45 Tooth



BGS285 1/4"
BGS286 3/8"
BGS287 1/2"

Stubby Ratchet 72 Tooth



BGS212 1/4"
BGS209 3/8"
BGS210 1/2"

Socket Set, Hexagon, deep
6.3 mm (1/4") Drive
4 - 13 mm
11 pcs.



BGS2221

Socket Set, Hexagon, deep
10 mm (3/8") Drive
8 - 19 mm
11 pcs.



BGS2222

Socket Set, Hexagon, deep
12.5 mm (1/2") Drive
10 pcs.



BGS2435

Bit Socket Set 1/4" Dr
T Star Tamperproof
T10,15,20,25,27,30,40,45,50



BGS2165

Bit Socket Set 1/4" Dr
Slot 4,5,5.5,6.5,7
PH 0,1,2,3



BGS2163

Bit Socket Set 6.3 mm (1/4") Dr
Internal Hexagon 4 - 12 mm
7 pcs.



BGS2161

**BGS 1/2" Drive Internal
Hexagon Bit 30 PCE**

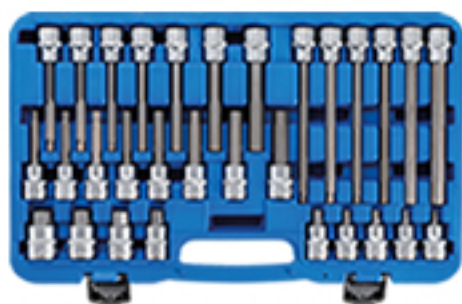

BGS5181

Hex Bit Set 1/2 Drive 30 Pce
Hex 5mm - 19mm
Lengths 55mm 100mm
140mm + 200mm

**BGS 1/2" Bit Socket
Assortment 49 PCE**



BGS5188

6 Pce T25-T60 X 100mm
10Pce T20-T70 X 55mm
9 Pce Hex 5-19mm X 55mm
5 Pce Hex 6-12mm X 100mm
4 Pce XZN 5-10 X 55mm
5 Pce XZN 6-14 X 100mm
9 Pce T20-T60 X 30mm
1 ADAPTOR

**BGS 1/4"+1/2" Car Assembly
Bit Set 38 PCE**



BGS5184

6 Pce 1/2" D T40-T70 X 140mm
2 Pce 1/2 D T30 x 300mm T80 x 100mm
7 Pce 1/2D XZN 9-18
4 Pce 1/2D Ribe 7-10
10 Pce 1/2D Hex 5-24mm
9 Pce 1/4 D TS10-TS50

**BGS 1/2" Spline Bit Socket
M17 26 PCE**

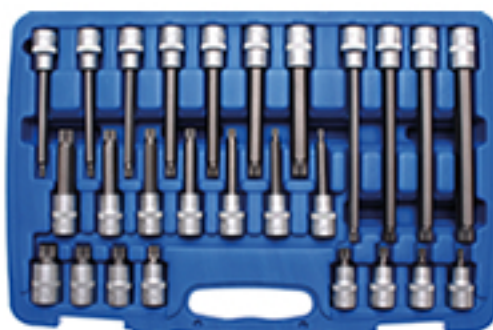

BGS5180

Hex Bit Set 1/2 Drive 26 Pce
Hex 4mm - 16mm
Lengths 55mm 100mm
140mm + 200mm



BGS2162

6 PCE
1/4" Drive XZN Set on
Rail Sizes 4-12



BGS8618

9 PCE
1/4" Drive Torx Set Ball
End Sizes T10-T50



BGS2161

7 PCE
1/4" Drive Hex Key Set on Rail
Sizes 4-12mm

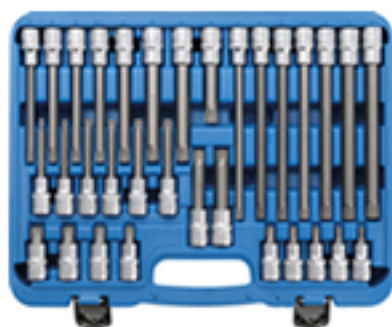

BGS5183

32 PCE
1/2" Drive Bit Set XZN
– Torx – Ribbe

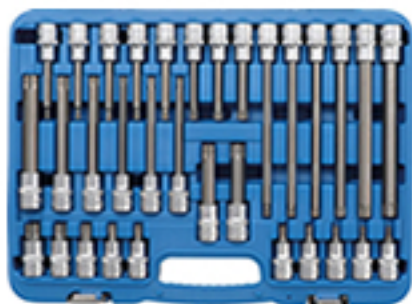

BGS5182

32 PCE
1/4-3/8-1/2" Drive Torx Bit Set
Sizes T20-T70



BGS2163

12 PCE
1/4" Drive Bit Set on Rail
PH- PZ – Slot

BGS2164



**Torx Bit Set 9 pce 1/4" Dr
T10-T50**

BGS5105



**XZN Set 8 pce 1/4" Dr M4 M-5
3/8" Dr M8-M10-M12
1/2" Dr M14-M16**

BGS5107



**Hex Bit Set 3/8" Dr 7 pce
3-4-5-6-7-8-10 mm**

BGS5108



**Torx Set 3/8" Dr 7 pce
T15-T20-T25-TT30-
T40-T45-T50**

BGS8885



**Tamperproof Torx Set
1/2" Dr 4 pce
T40-T55**

BGS8886



**Torx Torx Set
1/2" Dr 4 pce
T40-T55**

BGS8887



**Hex Bit Set 1/2" Dr 6 pce
6-14mm**

BGS5006



**Spline Bit Set 3/8" Dr
6 pce XZN
M5-M6-M8-M10-M12**

Combined Bit Set | 40 pcs.



BGS7071

Bit and Socket Set | E-Type /
T-Star (for Torx) | 30 pcs.



BGS5025

Socket Set, E-Type | 12.5 mm
(1/2") Drive | E10 - E24 | 9 pcs.



BGS6425

Impact Bit Socket Set | 12.5 mm
(1/2") Drive | T-Star (for Torx)
T20 - T70 | 10 pcs.



BGS5097

Bit Set | 6,3 mm (1/4") /
10 mm (3/8") Drive | T-Star
tamperproof (for Torx) | 11 pcs.



BGS786

Magnetic Bit-Holder,
extra strong | external Hexagon
6.3 mm (1/4") | 60 mm



BGS1727	60mm
E7567	75mm
E7568	150mm
E7569	200mm
E7570	250mm

Protective Impact Socket Set |
12.5 mm (1/2") Drive |
17 / 19 / 21 mm | 3 pcs.



BGS7200

Protective Impact Socket Set |
12.5 mm (1/2") Drive |
17 / 19 / 21 mm | 3 pcs.



BGS7300

BGS5016



6 pce Bit Set 3/8" Dr
T25-T55 in Foam Module

BGS5017



7 pce Bit Set 3/8" Dr
4-12mm in Foam Module

BGS9004



Quick Release Magnetic Holder
for Hex Bits and 1/4" Dr Sockets

BGS20100



122 pce Bit Set Hex-
Torx-Ph-PZ

BGS765



100 pce Bit Set 1/4" Dr Ph-Pz
- XZN - Torx

BGS763



32 pce 1/4" Bit Set Hex-
Pz - Ph- Slot

BGS9384



28 pce 1/4" Dr Sockets
6-13mm Bit Holder +
Pz-Ph-TX bits

BGS4816



32 pce Bit Set
Ph-Pz-TX-



Impact Socket 1/2" Drive

ELORA	BGS
790-10	5210
790-11	5211
790-12	5212
790-13	5213
790-14	5214
790-15	5215
790-16	5216
790-17	5217
790-18	5218
790-19	5219
790-20	5220
790-21	5221
790-22	5222
790-23	
790-24	5224
790-25	
790-26	
790-27	5227
790-28	
790-29	
790-30	5230
790-32	5232
790-34	



Impact Socket 1/2" Drive

ELORA	BGS
790LT-10	7210
	7211
	7212
790LT-13	7213
790LT-14	7214
	7215
790LT-16	7216
790LT-17	7217
790LT-18	7218
790LT-19	7219
790LT-20	
790LT-21	7221
790LT-22	7222
790LT-24	7224
790LT-27	7227
790LT-30	7230
790LT-32	7232

**Impact Socket
1/2" Sq Drive**

12 Point

No.	Size
BGS5343	24mm
BGS5336	27mm
BGS5337	30mm
BGS5338	32mm
BGS5339	33mm
BGS5340	34mm
BGS5341	35mm
BGS5342	36mm
BGS5344	38mm
BGS5351	39mm



		192
7901-125	23.24	193
7901-250	30.96	194



- 790IN 5
- 790IN 6
- 790IN 8
- 790IN 10
- 790IN 12
- 790IN 14
- 790IN 17
- 790IN 19

- 5481-4
- 5481-5
- 5481-6
- 5481-8
- 5481-10
- 5481-12
- 5481-14
- 5481-17
- 5481-19



- 7905-1/2" M 3/8" F
- 7902-3/8" M 1/2" F
- 174 1/2" M 3/8" F
- 173 3/8" M 1/2" F



- 790TX 30
- 790TX 40
- 790TX 50
- 790TX 55
- 790TX 60
- 5369 T20
- 5370 T25
- 5367 T27
- 5371 T30
- 5372 T40
- 5373 T45
- 5374 T50
- 5375 T55



Impact Socket 3/4" Sq Drive

Elora	BGS
791-17	5617
791-18	5618
791-19	5619
791-21	5621
791-22	5622
791-24	5624
79-25	
791-26	5626
791-27	5627
791-28	
791-29	
791-30	5630
791-32	5632
791-33	5633
791-34	5634
	5635
791-36	5636
791-38	5638
791-41	5641
791-46	5646
	5650
	5655
	5660
	5660A



Impact Socket 3/4" Sq Drive

Elora	BGS
791LT-17	5717
	5718
791LT-19	5719
	5721
791LT-22	5722
791LT-24	5724
	5726
791LT-27	5727
791LT-30	5730
791LT-32	5732
791LT-33	5733
791LT-34	5734
791LT-36	5736
791LT-38	5738
791LT-41	5741
791LT-46	5746
791LT-50	5750
791LT-55	5755
791LT-60	5760
791LT-65	

65mm 12 point
for Ford Transit Hub Nuts



Elora

JGS

7911-175
7911-250
7911-325

5651 100mm
5262 200mm



Impact Socket

Elora	BGS
791IN-10	5054-14
791IN-12	5054-17
791IN-14	5054-19
791IN-17	5054-21
791IN-19	5054-22
791IN-22	5054-23
791IN-24	5054-24



Elora

BGS

7912-1/2" M 3/4" F
7902-3/4" M 1/2" F

275
279



Impact Socket 1" Sq Drive

Elora	
992-19	
792-21	
792-22	
792-24	
792-24	
792-26	
792-27	5827
792-28	
792-29	
792-30	5830
792-32	5832
792-33	5833
792-34	5834
	5835
792-36	5836
792-38	5838
792-41	5841
792-42	
792-46	5846
792-50	5850
792-52	
792-55	5855
792-60	5860
792-65	5865
792-70	5870
75mm	5875
80mm	5880
85mm	5885
90mm	5890
95 mm	5895
105mm	5905
110mm	5910
115mm	5915
120	5920



Impact Socket 1" Sq Drive

Elora	BGS
292LT-21	21
792LT-22	22
792LT-24	24
792LT-27	27
792LT-30	30
792LT-32	32
792LT-33	33
792LT-34	34
792LT-36	36
792LT-38	38
792LT-41	41
792LT-46	46
792LT-50	50
792LT-55	55
	60
	65
	70
	75
	80
	85
	90
	95
	100
	105
	110
	115
	120



	Elora	BGS
7922	3/4"M 1" F	196
7912	1"M 3/4"F	195

Elora	BGS
7921-175	7921-175
7921-325	7921-325



**Impact Hex Key Set,
(1/2") Drive |
5 - 19 mm |
8 pcs.**



BGS5481

**Impact Torx Bit Set, |
1/2" Dr | T20-T70 | 9 pcs.**



BGS5480

**Impact Bit Set
XZN | 1/2" Dr |
M12-M18 |
8 pcs.**



BGS5381

**Impact Socket Set |
E Type (1/2") Dr |
E10-E24 | 9 pcs.**



BGS5204

**Impact Bit Set, XZN |
1/2" Dr M14-M18
| 6 pcs.**



BGS5380

**Impact Torx Bit Set |
3/4" Dr T55-T100
| 6 pcs.**



BGS5055

**Screw Extension Set |
3/8" Dr 10-19 mm | 10 pcs.**



BGS5265

**Impact Extension Set |
3/4" Dr 100 mm, 150 mm
250 mm | 3 pcs.**



BGS8840

Impact Socket Set



BGS5205

Hexagon | 12.5 mm
(1/2") Drive
| 10 - 24 mm
10 pcs.

Impact Socket Set



BGS5206

Hexagon, deep |
12.5 mm (1/2") Drive |
10 - 24 mm | 10 pcs.

Impact Socket Set



BGS5240

20 mm (3/4") Drive
| 22 - 38 mm | 8 pcs.

Impact Socket Set



BGS5207

Hexagon |
12.5 mm (1/2")
Drive | 10 - 32 mm |
14 pcs.

Impact Socket Set



BGS5245

Hexagon | 25 mm
(1") Drive
| 27 - 50 mm | 8 pcs.

Impact Socket Set



BGS5241

extra deep |
20 mm (3/4") Drive
| 22 - 38 mm | 8 pcs.

Impact Adaptor Set | 6 pcs



BGS200

Impact Bit Socket Set



BGS5054

20 mm (3/4") Drive
| int Hex, int spline
(for XZN) | 9 pcs.

Impact Adapt + Uni Joint Set



BGS25140

| 6.3 mm (1/4")
- 25 mm (1") |
11 pcs.

Torque Wrench



BGS975

1/4" Drive 1-5 Nm

Torque Wrench Set



BGS958

11 pce 40-210 Nm
13-30mm Including Sizes
13,14, 15, 17, 19,
22, 24, 27, 30mm

Torque Wrenches



BGS967	1/2" Dr	6-30Nm
BGS966	3/8" Dr	20-110Nm
BGS971	1/2" Dr	70-350Nm
BGS968	3/4" Dr	100-500Nm
BGS970	1" Dr	140-980Nm

Torque Multiplier



BGS1204

1/2" Dr	Input	300Nm
3/4"	Output	1000Nm

Angle Gauge



BGS3084

1/2" Dr 12.5mm

Angular Gauge for Angular Torque



BGS3070

1/2" Dr 12.5mm

Pneumatic Impact Wrenches



BGS3233
1/2" Drive 1756 NM



BGS3280
1/2" Drive 880 NM



BGS3235
3/4" Drive 1355 NM



BGS32805
3/4" Drive 1600 NM



BGS3240
1" Drive 2200 NM



BGS3260-1
Pneumatic Saw

E4140
Pack of 10 HSS Blades
for above 327 Pi



BGS3286
Pneumatic Saw



A741717
75mm x 1mm disc
for above



BGS8540
Pneumatic Needle
Descaler



BGS3515
Pneumatic Chisel
with 5 Chisels



BGS3236
Pneumatic Grease
Gun



BGS3264
Pneumatic Die
Grinder Short Version
170 mm
Long



BGS3271
Pneumatic Die Grinder
Long Version 340 mm
Long



BGS3269
Pneumatic Die Grinder
90° Version 155 mm
Long



BGS8956
Pneumatic Shear
Up to 1-2 mm Thick

Air Blow Guns



BGS3208 100mm
BGS3207 250mm
BGS3202 330mm

Air Hose with Fittings



BGS3250 10mtr



BGS3130 10mtr

Retractable Hose Reel 15mtr



BGS8584

Retractable Hose Reel 10mtr



BGS3297

High Performance Air Blow Gun with Venturi Nozzle



BGS8559

Air Hose Susie 6mtr



BGS66541



S2670
PCL Coupling
1/4" Female



S2670A
PCL Coupling
1/4" Male



S2669
PCL Tail
1/4" Male

S2669A
PCL Tail
1/4" Female



Code	Content
S2683	PCL Tail 3/8" Male
S2683A	PCL Tail 1/2" Male
S2683B	PCL Hosetail 3/8"
S2683C	PCL Hosetail 1/2"



S2682
PCL Coupling
1/2" Female
100 series

S2682A
PCL Coupling
1/2" Male
100 series



Code	Content
S2672	1/4" x 8mm
S2673	1/4" x 10mm
S2674	1/4" x 12mm



S2685A 8mm
S2685B 10mm



SS2685



S2809
Twin hold on
Connection for
MK4 PCL
Tyre Inflator

S2684



SSA37/93
MK3 PCL
Tyre Inflator

Water Tap 1/2"



S2800

Lubricator 1/2"



S2801

Air Line Reg.



S2805E

Filter Reg 1/2"



S2803

Regulator 1/2"



S2804

Airline Gauge Bottom Entry 200psi

S2690 1/8"bsp
S2691 1/4"bsp



Back Entry

S2693 1/8
S2694 1/4

Filter Reg Lubricator 1/2"



S2802

Galvo Bush



G2089 1/4" x 1/8"
G2091 3/8" x 1/4"
G2093 1/2" x 1/4"
G2094 1/2" x 3/8"

M.F Elbow



G2000 1/8"
G2001 1/4"
G2002 3/8"
G2003 1/2"

Galvo Socket



G3085 1/8"
G3086 1/4"
G3087 3/8"
G3088 1/2"

Galvo Tee



G2058 1/8"
G2059 1/4"
G2060 3/8"
G2061 1/2"

Ball Valve 1/4"



G1000

PUSH IN PNEUMATIC FITTINGS



STRAIGHT CONNECTORS

4mm	5mm	6mm	8mm	10mm	12mm
TU2411	TU2412	TU2413	TU2414	TU2415	TU2416



ELBOW CONNECTORS

4mm	5mm	6mm	8mm	10mm	12mm
TU2471	TU2472	TU2473	TU2474	TU2475	TU2476

TEE CONNECTORS



4mm	5mm	6mm	8mm	10mm	12mm
TU2451	TU2452	TU2453	TU2454	TU2455	TU2456

STUD CONNECTORS



4mm X 1/8	5mm X 1/8	6mm X 1/8	6mm X 1/4	8mm X 1/8
TU2601	TU2603	TU2605	TU2606	TU2604
8mm X 1/4	10mm X 1/8	10mm X 1/4	12mm X 1/4	12mm X 1/2
TU2608	TU2611	TU2610	TU2612	TU2614

STUD ELBOW CONNECTORS



6mm X 1/8	6mm X 1/4	8mm X 1/8	8mm X 1/4	10mm X 1/8	10mm X 1/4	12mm X 1/4
TU2666A	TU2666	TU2669	TU2668	TU2670A	TU2670	TU2672



REDUCING STRAIGHT CONNECTORS

6-4mm	8-6mm	10-8mm	10-6mm	12-10mm
TU2431	TU2433	TU2435	TU2434	TU2432

Nylon Tube in 30mtr Rolls



TU1211	4 mm
TU1221	6 mm
TU1231	8 mm
TU1241	10 mm
TU1251	12 mm

PVC Braided Tube in 30 Mtr Coils



TU1913	3/16	TU1917	1/2
TU1914	1/4	TU1918	5/8
TU1915	5/16	TU1919	3/4
TU1916	3/8	TU1920	1"

COPPER TUBE IN 7.5 MTR COILS



TU1505	3/16	TU1511	6 mm
TU1506	1/4	TU1512	8 mm
TU1507	5/16	TU1513	10 mm
TU1508	3/8		

Kunifer Brake Tube 7.5 Mtr Coils



TU1500	3/16	TU1496	6 mm
TU1501	1/4	TU1497	8 mm
TU1502	5/16	TU1498	10 mm
TU1503	3/8		

Cable Ties 100 Pce Pack



D1448	140 x 4.8mm
D1444	200 x 4.8mm
D1443	250 x 4.8mm
D1445	300 x 4.8mm
D1449	370 x 4.8mm
D1446	370 x 7.6mm

Flexible Exhaust Tube in 2 Mtr Lengths



T8497	1 1/2
T8498	2
T8499	2 1/2
T8500	3
T8501	3 1/2
T8502	4
T8503	4 1/2
T8504	5

Jubilee Clips



F1578	9.5-12mm	F1585A	32-45mm	F1592	90-120mm
F1579	11-16mm	F1586	35-50mm	F1593	110-140mm
F1580	13-20mm	F1587	40-55mm	F1594	135-165mm
F1581	16-22mm	F1588	45-60mm	F1595	158-190mm
F1582	18-25mm	F1589	55-70mm	F1596	184-216mm
F1583	22-30mm	F1589/1	60-80mm	F1587	216-242mm
F1584	25-31mm	F1590	70-90mm	F1598	235-267mm
F1585	30-40mm	F1591	85-100mm	F1599	266-292mm
				F1600	280-318mm

Rubber Airline Hose



TU1814	1/4
TU1815	5/16
TU1816	3/8
TU1817	1/2
TU1818	5/8
TU1919	3/4
TU1920	1

Heavy Duty Funnell 260 X170mm



BGS9934

Hose Cutter up to 38mm



BGS8869

Hose Cutter 4-14mm



BGS8868

Tub Cutter Ratchet Type to 35mm



BGS1946

Pipe Cutter 5-40mm



BGS1902

**Ball Pein Hammer
with Fibreglass Handle**



BGS3870 225g
 BGS3871 450g
 BGS3872 700g
 BGS3873 900g

**Elora Ball Pein Hammer
with Wooden Handle**



1670 1/2lb
 1670 3/4lb
 1670 1b
 1670 1 1/2lb
 1670 2lb

**Lump Hammer
with Fibreglass Handle**



BGS3847 1000g
 BGS3848 1250g
 BGS3849 1500g
 BGS3846 2000g

**Elora Club Hammer
with Wooden Handle**



1672 1000g
 1672 1250g
 1672 1500g
 1672 2000g

**Rubber Mallet
with Fibreglass Handle**



BGS1962 750g
 BGS1963 1200g

**Dead Blow Hammer
60mm Head**



BGS1868 1300g

**Copper Hammer
with Fibreglass Handle**



BGS892 2lb

Impact Drive Set



BGS710 5 pce



BGS711 4 pce

Circlip Plier 90° for External Circlips



BGS450-1 150mm A11
 BGS447-1 175mm A21
 BGS650-1 225mm A31
 BGS651-1 300mm A41

Circlip Plier Straight for External Circlip



BGS450-3 150mm A1
 BGS447-3 175mm A2
 BGS650-3 225mm A3
 BGS651-3 300mm A4

Circlip Plier 90° for Internal Circlip



BGS450-4 150mm J11
 BGS447-4 175mm J21
 BGS650-4 225mm J31
 BGS651-4 300mm J41

Circlip Plier Straight for Internal Circlips



BGS450-2 150mm J1
 BGS447-2 175mm J2
 BGS650-2 225mm J3
 BGS651-2 300mm J4

Circlip Plier Set 4 pce



BGS450 150mm
 BGS447 175mm
 BGS650 225mm
 BGS651 300mm

Circlip Plier Set 400mm Interchangeable Tips



BGS478

Internal/External Puller Set 5 pce



BGS6736
 External



BGS6737
 Internal

Circlip Pliers 90° 500mm

BGS6738
 Internal



BGS6739
 External



**Universal Shears
Stainless Steel 180mm**



BGS7962

**Stainless Steel Electricians
Scissors 145mm**



BGS7963

**Metal Tin Snips 260mm
Left Hand Cutting**



BGS1680

**Metal Tin Snips 260mm
Right Cutting**



BGS1681

**Locking Grip Plier
100mm**



BGS505

**Locking Grip Plier
225mm**



BGS4490

**Locking Grip Plier
Set 4pce**



**125mm/180mm/
250mm +
150mm Long Nose**

BGS494

**Locking Welding C Clamp
280mm**



BGS496

**Locking Welding C Clamp
110mm**



BGS507

**Lock Ring Plier
Set 3 pce**



BGS66110

**Lock Ring Plier for
Drive Shaft**



BGS66105 Plier 30 degrees Bent
BGS66107 Plier Straight
BGS66109 Plier Slightly Bent

**Adjustable Wrench with
Wide 38mm Opening**



BGS6839

**Water Pump Plier with
Daft Jaw Protectors**



BGS72321

**Long Nose Plier Set
5 pce**



290mm Long

BGS414

Bolt Cutters



BGS1917 200mm Mini
BGS1908 300mm
BGS1907 450mm
BGS1909 600mm
BGS1914 760mm
BGS1915 900mm

Bench Vice 100mm



BGS59260

Bench Vice 150mm



BGS59270

Price Set 3 pce



BGS358

Long Nose 200mm
Diagonal Cutter 165mm
Combination Plier 175mm

**Bent Nose Plier
200mm**



BGS373

Combination Plier



**BGS369
165mm**



**BGS370
175mm**



**BGS371
200mm**

Side Cutter



BGS381 115mm



BGS393 165mm

**Flat Nose Plier
160mm**



BGS378

Long Nose Plier



**BGS388
160mm**



**BGS389
200mm**

**Wire Stripping
Plier 150mm**



BGS361

**End Cutting
Plier 165mm**



BGS397

**End Cutting Plier
200mm**



BGS552

Water Pump Pliers



BGS75110 175mm

BGS75111 240mm

BGS75112 300mm

BGS75113 400mm

**Mechanics Pliers
250mm**



BGS556

**Waterpump Plier
Set 3 pce**

175mm/240mm/300mm



BGS457

Plier Set 5 pce



BGS330

Combination Plier	175mm
Side Cutter	165mm
Long Nose Straight	200mm
Long Nose Bent	200mm
Water Pump Plier	240mm

**Combination Plier
200mm**



BGS327

**Diagonal Side Cutter
165mm**



BGS331

**Long Nose Plier
200mm**



BGS337

**Water Pump Plier
240mm**



BGS342

**Heavy Duty Diagonal
Side Cutter 180mm**



BGS335

**Wire Stripping Plier
150mm**



BGS339

Cable Cutter 240mm



BGS329

Adjustable Wrenches



BGS1470	150mm
BGS1471	200mm
BGS1472	250mm
BGS1473	300mm
BGS1474	380mm
BGS1475	468mm
BGS1476	600mm



Steel Stilltons

BGS540	250mm
BGS541	300mm
BGS542	350mm
BGS543	450mm
BGS544	600mm

Aluminium Stilltons

SAK5108	350mm
SAK5109	450mm
SAK5110	600mm
SAK5111	900mm

Combination Edge Setter and Folding Plier



BGS6160

Pad Locks



BGS3096	30mm
BGS3098	40mm
BGS3099	50mm
BGS3100	60mm

Grease Gun



BGS3065

One Handed Grease Gun



BGS3140

Grease Gun Connection



BGS3143

Grease Gun Connection + Tube



BGS3066

Umeta Flexible Grease Gun Tubes

E9834	300mm
E9835	500mm
E9836	750mm

Mini Grease Gun 82 CM3



BGS71037

VDE Combination Plier 180mm



BGS7150

VDE Side Cutter 160mm



BGS7154

VDE Side Cutter Heavy Duty 180mm



BGS7155

VDE Long Nose Plier



BGS7151 160mm

BGS7152 200mm

VDE Wire Stripper 160mm



BGS7156

VDE Water Pump Plier 250mm



BGS7157

Automatic Wire Stripper



BGS442

0.13-6mm
210mm Long

Ratchet Crimping Tool



BGS1418 0.5-4mm

BGS1426 0.5-6mm

Crimping Tool Set with 5 Pairs of Jaws



BGS1410

Digital Multimeter



BGS63400

Digital Multimeter 3 1/2 Digital



BGS63402

Switch Board Keys



BGS9416

BGS9415



Q1000 30mm BRASS PADLOCK LN3
 Q1001 40mm LN4
 Q1001A 50mm LN5

**KEYED ALIKE,
 SAME KEY FITS ALL LOCKS**

Q1029 30mm LN3KA
 Q1030 40mm LN4KA
 Q1031 50mm LN5KA



Q1023 70mm
SHUTTER PADLOCK WL2

Q1024 90mm
 WL3



Q1019 70mm
DISC LOCK DCL1

Q1027 70mm
DISC KEYED ALIKE DCL1KA



LONG SHACKLE PADLOCK

Q1011 40mm
 Q1014A 50mm
 Q1014B 60mm



Q1044
RECOADABLE COMBINATION LOCK
 85mm CBW85



Q1032B
COMBINATION LOCK 30mm
 DCFCOMBO130



Q1032A **COMBINATION LOCK**
LONG SHACKLE
 CP40/2.5

Brush Set 38 pce



BGS3078

Brush Set 20 pce



BGS379

Chain Saw Sharpening Disc



BGS3178

100 x 4.5 x 10 mm

Chain Saw Sharpening Disc



BGS3177

100 x 3.2 x 10 mm



Carbide Tipped Circular Saw Blade

Item-No	Description	dla.	Teeth	Bore
BGS3950	Carbide tipped blade	160mm	36	30
BGS3952	Carbide tipped blade	190mm	24	30
BGS3953	Carbide tipped blade	210mm	40	30
BGS3954	Carbide tipped blade	254mm	40	30
BGS3955	Carbide tipped blade	300mm	30	30
BGS3957	Carbide tipped blade	315mm	30	30
BGS3958	Carbide tipped blade	350mm	40	30
BGS3956	Carbide tipped blade	400mm	48	30

Polishing Set for Soft Metals 7 pce



BGS3990

Polishing Set for Hand Metals



BGS3991

Tap + Die Set



BGS1927

44 pce M3-M12

Tap + Die Set



BGS1925

32 pce M3-M12

Tap + Die Set



BGS1893

45 pce M6-M24

Tap + Die Set



BGS1899

45 pce M6-M24
Tin Coated

Tap + Die Set



BGS1898

45 pce 1/4-1" UNF/UNC

Tap + Die Set



BGS900

110 pce
UNF/UNC/Metric
1/4-3/4 M6-M18

Tap + Die Set



BGS1900

110 pce
M2-M18

Ratchet Tap Wrenches



BGS1980

M3-M10-80mm

BGS1981

M5-M12-110mm

BGS1982

M3-M10-255mm

BGS1983

M5-M12-320mm

Helicoil Kit and Assortment Kit



BGS1952	M5 x 0.8 29 pcs
BGS1953	M6 x 1.0 29 pcs
BGS1954	M8 x 1.25 29 pcs
BGS1955	M10 x 1.5 29 pcs
BGS1956	M12 x 1.75 14 pcs
BGS1957	M14 x 1.25 14 pcs

Thread Repair Kit

BGS9431	29-pce, M7x1.0
BGS9427	29-pce, M8x1.0
BGS9435	29-pce, M9x1.25
BGS9428	29-pce, M10x1.25
BGS9436	14-pce, M11x1.5
BGS9437	14-pce, M12x1.0
BGS9429	14-pce, M12x1.5
BGS9430	14-pce, M14x1.5
BGS9432	12-pce, M16x1.5
BGS9433	7-pce, M18x1.5
BGS9434	7-pce, M20x1.5
BGS9438	7-pce, M24x2.0

Thread Repair Inserts

BGS9431-1	25-pce, M7x1.0
BGS9427-1	25-pce, M8 x1.0
BGS9435-1	25-pce, M9 x1.25
BGS9428-1	25-pce, M10 x1.25
BGS9436-1	10-pce, M11x1.5
BGS9437-1	10-pce, M12x1.0
BGS9429-1	10-pce, M12x1.5
BGS9430-1	10-pce, M14x1.5
BGS9432-1	5-pce, M16x1.5
BGS9433-1	5-pce, M18x1.5
BGS9434-1	5-pce, M20x1.5
BGS9438-1	3-pce, M24x2.0



BGS1950

130 pce M5-M12

BGS1951

130 pce M6-M14



File Set 5 pce

Flat 200mm Course
Flat 200mm Med/Fine
Half Round 200mm Course
Triangular 150mm Med/Fine
Round 150mm Course

BGS8494

Needle File Set



140mm Long

BGS50200

De Burring Tool



BGS8328



E4154

PK 10

Stud Extractor



6.3-14mm

BGS1903

Tyre Lever Set 4 pce



300-400-500-600mm

BGS1548

Mechanic Pry Bar Set



**12x200mm/18x300mm
20x450mm/20x600mm**

BGS9135

Flat Ripping Bar 380mm



BGS52138

Wrecking Bars



BGS52104

400mm

BGS52106

600mm

BGS52109

900mm

5 pcs Scraper and Hook Set

**BGS9132**

4 pcs Hook Set with Rounded Tips

**BGS9439**

Hook Set 4 pcs

**BGS8451**

Storage Box 23 Compartments

320mm wide x 380mm Long x
65mm High**BGS9456**

Step Drill Set 3 pce M3-M30

**BGS1624**

Includes Sizes:

4-12mm

4-20mm

4-30mm

Step Drills:

BGS1618 4-12mm

BGS1619 4-32mm

BGS1615 4-40.5mm

Precision Mechanics Screwdriver and Hook Set

**BGS8833**Flat. PH. And TX Screwdrivers
170mm Long

Parallel Pin Punches on SB Hanger



- BGS1651-3 3-150mm
- BGS1651-4 4-150mm
- BGS1651-5 5-150mm
- BGS1651-6 6-150mm
- BGS1651-7 7-150mm
- BGS1651-8 8-150mm
- BGS1651-10 10-150mm
- BGS1651-12 12-150mm

Chisel + Punch Set 28 pce



BGS1650

Parallel Pin Punches with Grip



- BGS9081 8-225mm
- BGS9082 10-240mm
- BGS9083 12-260mm
- BGS9084 14-275mm
- BGS9085 16-290mm

Pin Punch Set 18 pce



BGS1695

1-5 -9.5mm

Parallel Pin Punch Set 6 pce



BGS1651

3-4-5-6-7-8mm

Punch + Chisel Set 15 pce



BGS1641

Centre Punch Set 6 pce



BGS1656

3-4-5-6-7-8mm

Automatic Centre Punch



BGS2085

Screwdriver with External Hexagon



- Blade Length 75mm
- BGS7916 Slot SL 3.2 mm
- BGS7917 Slot SL 5 mm
- Blade Length 38 mm
- BGS7918 Slot SL 6 mm
- Blade Length 100 mm
- BGS7919 Slot SL 6 mm
- Blade Length 150 mm
- BGS7920 Slot SL 8 mm
- Blade Length 200 mm
- BGS7921 Slot SL 9.5 mm

Screwdriver



- BGS7910 Cross Slot PH0 Blade 75 mm
- BGS7911 Cross Slot PH1 Blade 75 mm
- BGS7912 Cross Slot PH2 Blade 38 mm
- BGS7913 Cross Slot PH2 Blade 100 mm
- BGS7914 Cross Slot PH3 Blade 150 mm
- BGS7915 Cross Slot PH4 Blade 200 mm

Screwdriver T-Star (for Torx)



- BGS4913 T6 Length 80 mm
- BGS4914 T7 Length 80 mm
- BGS4915 T8 Length 80 mm
- BGS4916 T9 Length 80 mm
- BGS4917 T10 Length 80 mm
- BGS4918 T15 Length 80 mm
- BGS4919 T20 Length 80 mm
- BGS4920 T25 Length 100 mm
- BGS4921 T27 Length 100 mm
- BGS4922 T30 Length 100 mm
- BGS4923 T40 Length 150 mm

Screwdriver T-Star (for Torx)



- BGS4932 Cross Slot PZ1 Blade Length 75 mm
- BGS4933 PZ2 Blade Length 100 mm
- BGS4944 T15 Blade Length 250 mm

2 PCE Phase Tester



- BGS721
- 140mm and 190mm

7mm Jubilee Clip Driver 280mm Long



BGS7827

Screwdriver Set 5 pce**BGS7943**

Slot 4 x 80 / 5.5 x 125 /
6.5 x 150 mm
PH1 x 80 mm / PH2 x 100 mm

Screwdriver Set 7 pce**BGS7944**

Slot 4 x 80 / 5.5 x 125 /
6.5 x 150 / 8 x 200 mm
PH 1 x 82 / PH 2 x 100
PH 3 x 150

Screwdriver Set 8 pce**BGS8629**

Slot 1.5 x 75 / 2 x 75 / 2.5 x 75 /
3 x 100 / 4 x 100 / 5 x 150 /
6 x 150 / 8 x 200mm

**Splined (XZN) Screwdriver
Set 5 pce****BGS7924**

M4 / M5 / M6 / M8 / M10

Screwdriver Set 5 pce Hammer Through**BGS35840**

PZ1 x 75 / PZ2 x 100
Slot 5 x 75 / 6 x 100 / 8 x 150 mm

Screwdriver Set 12 pce



Flat

BGS7895

- | | |
|---------|---------|
| 3.2x72 | Ph0x75 |
| 5.0x75 | Ph1x75 |
| 6.0x100 | Ph2x100 |
| 6.0x38 | Ph2x38 |
| 8x150 | Ph3x150 |
| 9.5x200 | Ph4x200 |

Screwdriver Set 12 pce



Flat

BGS7890

- | | |
|---------|---------|
| 3.2x72 | Ph0x75 |
| 5.0x75 | Ph1x75 |
| 6.0x100 | Ph2x38 |
| 6.0x38 | Ph2x100 |
| 8x150 | Ph3x150 |
| 9.5x200 | Ph4x200 |

VDE Screwdriver Set 6 pce



BGS35816

- | | |
|--------------------|------|
| 0.8x4x100mm | Flat |
| 5.5x75mm | Flat |
| 6.5x100mm | Flat |
| PZI / P22 x 100mm | |
| Phase Tester 140mm | |

Precision Screwdriver Set 6 pce

BGS35807

- | | |
|---------------------|------|
| 0.3x1.4x50mm | Flat |
| 0.4x2.0x50mm | Flat |
| 0.4x2.5x50mm | Flat |
| PH00/PH0/PH1 x 50mm | |



VDE Screwdriver Set 8 pce

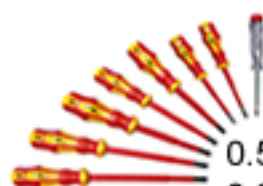

BGS35838

- | | |
|--------------------|------|
| 0.5 x 3 x 75mm | Flat |
| 0.8 x 4 x 100mm | Flat |
| 1.0 x 5.5 x 125mm | Flat |
| 1.2 x 6.5 x 150mm | Flat |
| Phase Tester 140mm | |

VDE Screwdriver Set 5 pce



BGS35815

- | | |
|--------------------|------|
| 0.5 x 3 x 75mm | Flat |
| 0.8 x 4 x 100mm | Flat |
| PH1/PH2 x 80mm | |
| Phase Tester 140mm | |

Tamperproof Torx Screwdriver Set 11pce



BGS7845

T6-T40

Precision Torx Screwdriver Set 6 pce



BGS35808

T6/T7/T8/
T9/T10/T15

Torx Screwdriver Set 11pce



T6-T40

BGS7844

Hacksaw 300mm



BGS2079

300mm Hacksaw Blades
Blades

Junior Hacksaw 150mm



BGS2083

Junior Hacksaw Blades
150mm
Blades Ph10

Mastic Gun Heavy Duty



BGS3510

Mastic Gun

BGS3511



220mm



BGS3513

380mm

Precision Vernier Caliper



BGS1932 150mm

BGS1933 200mm

BGS1934 300mm

Digital Caliper 150mm



BGS1930

Micrometer 0-25mm



BGS1935

Digital Micrometer
0-25mm



BGS8427



Lazy Tongs Rivet Gun



BGS398
3.2-6.4mm

Hand Rivet Gun 250mm



BGS400 2.4-4.8mm



Pop Rivet Assortment 50 pce

BGS75849
4.8mm

Rivet Gun



BGS405

Nut Riveter



BGS408

M3 - M10 | 68 pcs.

Nut Riveter

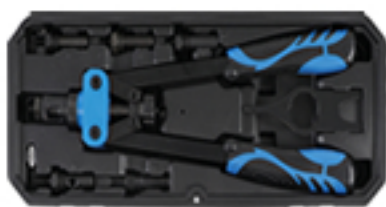

BGS404

M3 - M8 | 7 pcs.

Rivet Nuts Assortment



BGS14127

Aluminium | 150 pcs.

Rivet Nuts Assortment



BGS14126
Galvanized Steel |
150 pcs

Pop Rivet Assortment 400 pce

BGS8058
2.4-4.8mm



Hex Key Set 9 pce



1.5-10mm

BGS790

Hex Key Set 9 pce



1/16-3/8"

BGS799

**Hex Key Set Long Series
8 pce**



2-10mm

BGS802

**Hex Key Set Extra Long
9 pce**



1.5-10mm

BGS808

**Hex Key Set Ball End
Extra Long 9 pce**



1.5-10mm

BGS35100

Hex Key Set 8 pce



2-10mm

BGS7842

**Hex Key Set T Handle
5 pce**



3-8mm

BGS773

**Hex Key Set L Type
8 pce**



2-10mm

BGS8484

**Torx Key Set
T10-T50 9 pce**

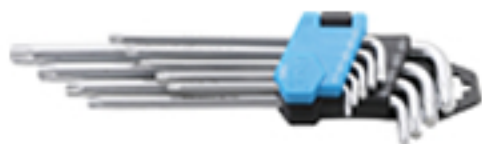

BGS793

**Short Tamperproof Torx
Key Set T10-T50
9 pce**



BGS809

**X Long Tamperproof
Torx Key Set T10-T50
9 pce**



BGS794

**Tamperproof Torx Key Set
T10-T50 9 pce**



BGS35105

**X Long Tamperproof
Torx Plus Key Set TS10-TS50
9 pce**



BGS777

**T Handle Torx Key Set
T10-T50
9 pce**



BGS8485

Easy Out Screw Extractor Set



BGS1895
5 pce 1-5, for bolt sizes
3-19mm

BGS1896
6 pce 1-6, for bolt sizes
3-25mm

BGS1897
8 pce 1-8, for bolt sizes
6-50mm

**HSS Screw Extractor Easy Out Set
25 pce**



BGS8462

Step Drill Set



BGS1624

| Ø 4 - 30 mm |
3 pcs.

Universal Cutter



BGS50605

Single Stepped Drill



BGS1618 4-22mm
BGS1619 4-32mm
BGS1615 6-40.5mm

Safety Cutter



BGS50606

Chainsaw files in packs of 2 pce

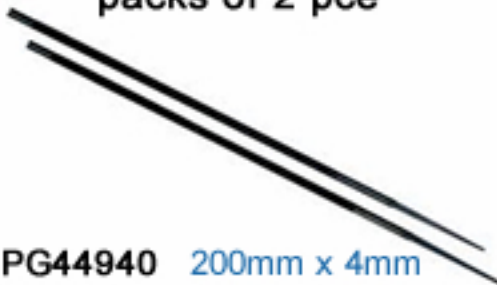

PG44940 200mm x 4mm
PG44950 200mm x 4.8mm
PG44960 200mm x 5.6mm

Trimming Knife Blades 5 pce



BGS7975

Thread Files

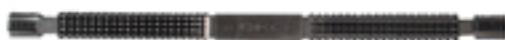

BGS1922 MM
BGS1923 SAE
BGS1929 WW

Snap Off Knife



BGS7955 18mm



BGS7971
Blades for 7955 10 pce

ALUMINIUM POP RIVET SET



2.4 – 4.8MM 400PCE
BGS8058

STEEL RIVET NUT ASSORTMENT



3-10MM 150PCE
BGS14126

ALUMINIUM RIVET NUT ASSORTMENT



3-10MM 150PCE
BGS14127

DOME NUT ASSORTMENT



M3 + M10 150PCE
BGS14130

WASHER ASSORTMENT



720PCE
BGS8113

WING NUT ASSORTMENT



M5 M6 M8 75PCE
BGS8133

SCREW HOOK ASSORTMENT



151PCE
BGS8136

CLEVIS PIN ASSORTMENT



60PCE
BGS8137

LYNCH PIN ASSORTMENT



4.5 6 8 10MM 50 PCE
BGS8087

QUICK LINK ASSORTMENT



3.5 – 8MM 20PCE
BGS8078

U TYPE CUSHION AND SCREW ASSORTMENT

170PCE

BGS8114



104

GRUB SCREW ASSORTMENT METRIC + UNC



160PCE
BGS14135 / BGS14136

HOSE CLIP ASSORTMENT



16-40MM 26PCE
BGS8055

HOSE CLIP ASSORTMENT



6-16MM 18PCE
BGS14145

HOSE CLAMP ASSORTMENT



26PCE
BGS80859

STAINLESS STEEL CLAMP ASSORTMENT



5.8 – 21MM 170PCE
BGS14115

CAR FUSE ASSORTMENT MINI



121PCE
BGS8109

CAR FUSE ASSORTMENT STANDARD



92PCE
BGS8124

CAR FUSE ASSORTMENT MAXI



24PCE
BGS8127

INSULATED FERRULES ASSORTMENT



685PCE
BGS14120

CABLE LUG ASSORTMENT



360PCE
BGS14110

ELECTRICAL CLIP ASSORTMENT

28PCE
BGS8138



SHRINK TUBE ASSORTMENT BLACK

28PCE
BGS8042



105

SHRINK TUBE ASSORTMENT COLOURED

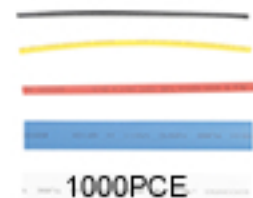

1000PCE

BGS8123

BGS GREASE NIPPLE ASSORTMENTMM/AF



6-8-10MM
1/8 1/4 70PCE
BGS8065-1

BGS GREASE NIPPLE ASSORTMENT



6-/8/10MM 110PCE
BGS8065

SPRING ASSORTMENT



200PCE
BGS8047

SPLIT PIN ASSORTMENT



1.6-4MM 444PCE
BGS8048

EXTERNAL CIRCLIP ASSORTMENT



3-32MM 300PCE
BGS8046

INTERNAL CIRCLIP ASSORTMENT



3-32MM 300PCE
BGS8049

E CLIP ASSORTMENT SET



1.5+22MM 300PCE
BGS8039

ROLL PIN ASSORTMENT



2-10MM 450PCE
BGS8054

CLEVIS PIN ASSORTMENT



60PCE
BGS8137

R CLIP ASSORTMENT



2.4 + 4MM 150PCE
BGS8043

WOODRUFF KEY ASSORTMENT



80PCE **BGS8117**

FEATHER KEY ASSORTMENT



60PCE **BGS8141**

**INJECTION COPPER
WASHER
ASSORTMENT**



150PCE
BGS8120

**SEAL RING COPPER WASHER
ASSORTMENT**



150PCE
BGS8052

**COPPER SEAL RING
ASSORTMENT**



300PCE
BGS8142

**COPPER WASHER
ASSORTMENT
METRIC**



75PCE
BGS8132

**COPPER WASHER
ASSORTMENT AF**



75PCE
BGS8144

**DOWTY WASHER
ASSORTMENT**



150PCE
BGS9306

O RING ASSORTMENT



3-22MM 225PCE
BGS8044

O RING ASSORTMENT



18-50MM 285PCE
BGS8105

**SEAL RING
ASSORTMENT
RUBBER AND FIBRE**



141PCE
BGS8059

**RUBBER GROMMET
ASSORTMENT AF**



180PCE
BGS8112

**RUBBER GROMMET
ASSORTMENT METRIC**



180PCE
BGS8125

**EYE INSTILLATION
SET**



103PCE
BGS8111

Workshop Creeper



1000mm x 420mm

BGS2992

**Mechanics Creeper with
Drawer + Storage**



BGS2832

Knee Protector Pad



480 x 320 x 36mm

BGS4800

Knee Protectors Pad



1200 x 540 x 30mm

BGS4804

Hand Pump 200ml



BGS4067

Hand Pump 1500ml



BGS4068

Fuel Line Pliers 230mm



BGS8260

Chain Pipe Cutter 250mm



BGS134

Oil Filter Strap



BGS1008 20-190mm

Oil Filter Strap



50-130mm BGS1054

Oil Filter Chain Wrench



BGS1002 60-115mm

Oil Filter Wrench



460mm BGS1021

Fluid Flask



BGS9984 1 Litre

Fluid Flask



5 Litre BGS8569

Oil Drain Pans



BGS9979 3.5 LTR
BGS9981 8 LTR
BGS9980 15LTR

Oil Changing Can with Nozzle



8 Litre
BGS9982

Chain Oil Filter 1/2" Dr



100mm

BGS1020

Oil Filter Wrench 1/2" Dr



BGS1033

65-115mm

Oil Filter Wrench
1/2" / 3/8" Dr



BGS1030

80-135mm

Oil Filter Wrench



BGS1032

95-150mm

Oil Filter Wrench



BGS1011

60-160mm

Oil Filter Strap



BGS8793

125-145mm

Oil Filter Wrench



BGS1027

110-155mm

Oil Filter Wrench



BGS1028

60-105mm

Piston Ring Compressors



BGS1887 60-90mm
BGS1888 57-125mm
BGS1889 100-160mm

Valve Spring Compressor



BGS1877
73-130mm

Valve Spring Compressor



BGS1878
35-200mm

Magnetic Lifter



BGS3091
660mm .5kg

Magnetic Lifter



BGS3088
670mm 2.2kg

Magnetic Lifter



BGS3188
650mm 3kg

Magnetic Pick Up Tool/ Inspection Mirror



BGS3086

Claw Type Magnetic Lifter



23mm Opening
800g

BGS3094

Magnetic Set



6 pce 9.5kg

BGS79919

Magnet Set 2pce



48x22x10mm
BGS79901

Magnet Set 6 pc 25mm



BGS79905

111

Power Pullers



BGS3480 500Nm

BGS3482 1000Nm

Internal/External Two Leg Pullers



BGS7713 15-120mm
 BGS7714 20-140mm
 BGS7716 25-195mm
 BGS7718 40-225mm

Internal/External Three Leg Pullers



BGS7723 15-100mm
 BGS7724 20-110mm
 BGS7726 27-160mm
 BGS7728 30-210mm

Universal Puller Set 7 pce



BGS7785
 Leg Lengths
 120/230/280mm
 Width 60-180mm



Parallel Puller, 2-legs

BGS7780 40-95mm x 100mm deep
 BGS7781 50-130mm x 100mm
 BGS7782 50 - 150mm x 150mm
 BGS7783 50- 200mm x 150mm
 BGS7784 50-240mm x 200mm

Miniature Puller Set



BGS7738
 19-45mm

Puller Set 2/3 Leg 13 pce

BGS7760
 Puller depth
 105/210/265mm
 Width up to 135mm
 Spindles 165 + 280mm



Internal/External Puller Set 5 pce



BGS7734
 External 40-80mm
 Internal 50-150mm

Blind Hole Bearing Puller Set



BGS7710
 Clamping depth 125mm
 Spindle Length 125mm

Hydraulic Puller Set 25pce



BGS7729

Leg Length

100, 150, 200mm

Bearing Separator

BGS7741



5-63mm

Bearing Separator



BGS7749

50-75mm

Bearing Separator



BGS7742

18-83mm

Puller Set 3 pce Internal/External



BGS7730

75mm/100mm/150mm

Bearing Puller



TI11080

150mm

TI11081

200mm

TI11082

250mm

TI11083

300mm

Digital LCD Protractor with Level mm



BGS50440

Protractor



E9235 400mm



E9234 210 x 400mm

Hydraulic Bottle Jacks



BGS9881	2 TON	Max 316mm	Min 168mm
BGS9882	3 TON	Max 363mm	Min 188mm
BGS9883	5 TON	Max 402mm	Min 207mm
BGS9884	8 TON	Max 447mm	Min 222mm
BGS9885	10 TON	Max 447mm	Min 222mm
BGS9887	15TON	Max 457mm	Min 227mm
BGS9888	20TON	Max 445mm	Min 235mm



BGS1156 3 ARM 58-80mm 50mm Head

BGS1157 3 ARM 58-168mm 100mm Head

BGS1148 3 Spare 50mm Heads for 1156

BGS1147 3 Spare 100mm Heads for 1157

Cylinder Hone



Gas Torch



BGS9872

Scraper Set 3 pce



BGS363

Hot Air Gun 2000W 220 Volt



BGS8495

2 Settings 400°C/
600°C

Gas Soldering Torch Kit



BGS9942

Soldering Irons



E3060 15WATT
E3061 40WATT
E3062 60WATT

Felder Solder 5-ph 505n 50



W1940	1.5mm 0.10kg
W1940A	1.5mm 0.25kg
W1941	2.0mm 0.10kg
W1942	2.0mm 0.25kg
W1897A	1.6mm Silver Solder

Ball Joint Separator



BGS1804

Fork Opening 20mm
Max Jaw Width 50mm

Ball Joint Puller



BGS1802

Clamping depth
10-40mm

Ball Joint Separator



BGS1795

Fork Opening 20-22mm
Jaw Width 30-55mm

Oil Pump 12 Volt



BGS9910

Max Flow for Engine Oil 3 L/Min
Max Flow for Diesel/Heating Oil
250 L/H

**Pipe Wrench Set
1/2" Dr**



BGS8450
14-17-19mm

**Alternatur Bit Socket
Set 1/2" Dr 13 pce**



BGS4246

**Spark Plug Thread
Repair Kit M14
16 pce**

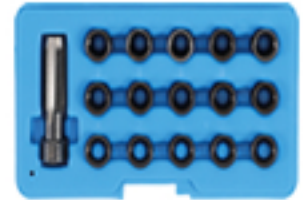

BGS149

**Spark Plug Socket
3/8" Dr 16 mm**



BGS2471

**Spark Plug Socket
1/2" Dr 16mm**



BGS2472

**Spark Plug Socket
1/2" Dr 21mm**



BGS2470

**Feeler Gauge Set
13 pce**

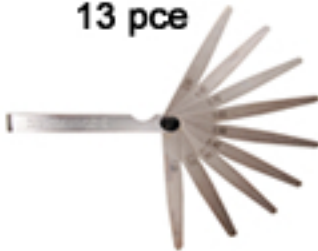

BGS3082
100mm Long
0.05-1.0mm

Feeler Gauge Set 20 pce



BGS3083
100mm Long
0.05mm-1.0mm
0.05 Steps

Flaring Tool Kit



BGS3057
3/16-(4.75mm)
1/4(6mm) 8mm

**Double Flaring
Tool Kit**



BGS8615
3/16(4.75mm) 5-6-8
10- 1/4 + 1/2"

Flaring Tool Kit



BGS360 4.7-16mm

116

Tube Bender



BGS3062
6-8-10mm

Tube Bending Tool



BGS3061
4-10mm

Tube Bending Tool



BGS3062
6-8-10mm Tube

Tube Bending Plier



BGS8718
3/16-1/4-5/8-3/8"
Tubes

Hose Pipe Cutter



BGS1902
4-40mm

Tube Cutter



BGS8340
3-25mm

Tube Cutter



BGS1905
3-22mm

Tube Cutter



BGS1906
3-28mm

**Magnifying Glass
100mm**



BGS85860

3 x Magnification

**Drill Sharpening
Tool**



BGS3200
3-19mm

Hole Punch Set 14 pce



BGS566 3-35mm



**Fisco Satellite Tapes
Polyester Coated Steel Tape**



E2505 20mtr
E2506 30mtr



**Fisco Futura
Fibreglass Tape**



E2507 20mtr
E2508 30mtr

Fisco Tapes MM/AF

E1542-3 3mtr
E1542-5 5mtr
E1542-8 8mtr



**Fisco Tapes Metric
Only**

E2501 5mtr
E2502 8mtr

**Stanley Fat Max
Tapes**



E2500 5 mtr
E2500A 8 mtr
E2500B 10 mtr

Combination Square



34703 300mm

Combination Square Kit



34704 300mm

Stabila 250mm Level



M3027SM Magnetic Level
M3027S Non Magnetic

Guide 577 PP Grey Grip

Thin work glove with nitrile



- Seamless in nylon
- Tight Fit
- Good breathability

CE CE Category 2



W1481 | 577 PP | S 9

W1482 | 577 PP | S 10

Guide 582 PP Black Grey Grip

Working glove in nitrile



- Seamless in nylon
- High comfort, microporous/breath
- dotted for extra durability

CE CE Category 2



W1480 | 582 PP | S 9

W1479 | 582 | S 10



Guide 540 PP Grey Grip

Working glove with nitrile



- Seamless in polyester
- Foamed nitrile
- Palm dipped
- Good grip

CE CE Category 2



W1478 | 540 PP | S 9

Guide 525 UP Black Grip

Thin working glove in PU



- Seamless in nylon
- High comfort
- Palm dipped
- Airy

CE CE Category 2



W1476 | 525 UP | S 9

W1477 | 525 UP | S 10



Guide 280 Gloves

Welding glove in cow split leather

- Fully lined
- Kevlar Seams
- Length 35 cm



W1475 | 280 | S 10 **W1475A | 280 | S 11**

CE CE Category 2



EN420



ESAB Curved Tig Glove



W1546D Size 9 Large
W1546E Size 10 X Large
W1546F Size 11 XX Large

**Red Welder
Gauntlet**



W1460

Tig Welders Glove



W1458

Welders Sleeve



W1422

Welders Apron



W1419

**Proban Welders
Flame Retardant
Overalls**



Sizes 38 to 50

**Green Gripster
Glove**



W1455A

**Orange Gripster
Skins pk 50**



W1548C Medium
W1548B Large
W1248C X Large
W1248D XX Large

Poly Flex Glove



W1446

120

**Black PU Grip
Glove**



W1447 Size 8
W1447AA Size 9
W1447AB Size 10



ESAB Clear Safety Specs

W1350



ESAB Dark Spec SH 5
for Plasma or
Flame Processes

W1344



Clear Goggle

W1348



© White Rose Tools

Plastic Headshield
4 1/4" X 3 1/4" 8KB

W1329



Plastic Headshield
4 1/4" X 3 1/4" 4KB

W1328



Light Reactive Vario
Headshield Shade
Variable
from SH9-SH13

W1555



Clearway Visor Complete

W1290

Replacement Screen **W1291**



Clearway Shaded
Visor, SH5

W1288

Replacement Screen
W1288A



Cup Dust Mask P2
Valved

W1414



Cup Dust Mask P3
Valved

W1415



PG50470

Respirators with
Two Cartridges



PG50475

Replacement Cartridge
for A1 Paint.
Solvents Organic Vapours



PG50478

Replacement Cartridge
for P3 Dust



PG50450

Respirator with
Single Cartridge



PG50455

Replacement Cartridge
for Paint. Solvents. Organic
Vapours



PG50458

Replacement Cartridge
for Dust P3



W1403A

3M 75mm Half Mask

W1404

Replacement Filter P3
7500 Mask



L1095

Handcleaner Orange
4.5 LTR

Butane Regulator



TI23000

Butane Reg
Low Pressure
1.5Kg/h

Butane Regulator



TI23000A

BUTANE REG HIGH PRESSURE
4Kg/H

Propane Regulator



TI23001

Propane Reg 2 Bar
6Kg/H

Cooking Regulator



TI23013

Cooker REG37MB
1.5Kg/H

Propane Hose



W1106A

Propane Hose 100 MTR Coil

Propane Adaptor



W1274

Propane Adaptor

Blowtorch



TI20000

Blowtorch

Long Blowtorch



TI200001

Long Blowtorch

Copper Tectic Rod



W1896A

Copper Tectic
Rod
2.4mm per KG

Superego Powerfire Compact Mapp Gas Torc

R3120



Superego Powerfire Compact Mapp Torch + Mapp Gas Cylinder

R3121



Blowtorch

B4064



Mapp Gas Cylinder 400g

M2006A



1060 Blowlamp



B4060
Including 306ml
cartridge

Replacement Cartridge:

B4061 306ml
B4061a 600ml

Blowlamp



Replacement 190g Cartridge:

B4063
with 4x190g
cartridge

RTM Mapp Gas Torch



B4067A

Turbo Torch TX504



B4067
Mapp Gas
Torch



W1015EL
Oxygen Regulator
Single Stage
Two Gauge 0-10 Bar



W1016EL
Acetylene Regulator Single Stage
Two Gauge 0-1.5 Bar



W1020EL
Argon Regulator
Single Stage
Two Gauge 35LPM



W1022
Argon Flowmeter
0-15LPM



W1019B
Propane Regulator
Single Stage
Two Gauge 20 Bar



W1055
Nitrogen Regulator 0-10 Bar
W1055A
Nitrogen Regulator 0-40 Bar



W1039
Oxy Acetylene Cutter 18" Long
W1039XL
Oxy Acetylene Cutter 36" Long

ANM Acetylene Cutting Nozzles



W1169	1/32	3-6 mm
W1170	3/64	6-20 mm
W1171	1/16	20-75 mm
W1172	5/64	75-125 mm
W1173	3/32	125-175 mm
W1174	1/8	175-300 mm

PNM Propane Cutting Nozzles



W1176	1/32	3-6 mm
W1177	3/64	6-20 mm
W1178	1/16	20-75 mm
W1179	5/64	75-125 mm
W1180	3/32	125-175 mm
W1181	1/8	175-300 mm

Type 5 Cutting Attachment



W1009EL

Type 5 Welding Shank



W1004EL

Acetylene Mixer



W1005EL

Swaged Welding Nozzles



W1147	size 1
W1148	size 2
W1149	size 3
W1150	size 5
W1151	size 7
W1152	size 10
W1153	size 13

Electrode Holder



W2530 400 amp
Electrode Holder

W2531 600 amp
Electrode Holder

Earth Clamp



W2538 200 amp Earth Clamp

W2539 400 amp Earth Clamp

Chrome Earth Clamp



W2540 600 amp
Chrome
Earth Clamp

Brass Earth Clamp



W2541 600 amp
Brass Earth Clamp



W2537 200 amp
Brass Earth Camp
W2536 400 amp
Brass Earth Clamp

Magnetic Earth Clamp



W2512 ESAB Magnetic
Earth Clamp 600 amp

Reusable Lugs



W2546 25mm
W2547 35mm
W2548 50mm

Works Anti Spatter



L1211 600ml
L1210 300ml

Dinse Plugs and Sockets



W2561 10-25mm Plug
W2563 35-50mm Plug
W2565 50-70mm Plug



W2560 10-25mm Socket
W2562 35-50mm Socket
W2564 50-70mm Socket



BGS3008 Welding Positioning
Magnet 22Kg Capacity

BGS3009 Welding Positioning
Magnet 33Kg Capacity

Welding Cable



W2554 25mm
W2555 35mm
W2556 50mm
W2557 70mm

TELWIN WELDERS



W2761
Technology 186 ACX
Inverter Welder
230 Volt in Aluminium
Case with Arc
Welding Leads



W2762
Tecnic 171/S
Inverter Welder
230 Volt in Aluminium
Case with Arc Leads



W2768
Infinity 220 Inverter
Welder
230 Volt with
Arc Leads



W1468
Montana Premium
Mig Gloves



W1459
Oregon Premium Tig
Welding Gloves



W2747
Mig Torch Magnetic
Holder



W2748
Tig Torch Magnetic
Holder

TIG TORCHES



W2168

WP9 Tig Torch
4 MTR Long
Torch Head
W2170



Collet

1.6mm 13N22 **W2171**
2.4mm 13N23 **W2172**
3.2mm 13N24 **W2173**



Collet Body

1.6mm 10N27 **W2174**
2.4mm 10N28 **W2175**
3.2mm 10N29 **W2176**



W2183

Short Back Cap
41V33



**Ceramic
Nozzles**

13N08 6mm **W2177**
13N09 8mm **W2178**
13N10 10mm **W2179**
13N11 11mm **W2180**
13N12 12mm **W2181**
13N13 16mm **W2182**



W2184

Long Back Cap
41V24



**Tig Torch
Type 17 17V AND 26**

W2196A Tig Torch 8 MTR
W2197 Torch Neck 17
W2197A Torch Flexible
Neck 17F



W2197B

Torch Neck
Flexible 26F



Collet

1.6mm 10N23 **W2198**
2.4mm 10N24 **W2199**
3.2mm 10N28 **W2200**



Collet Body

W2201
1.6mm 10N31
W2202
2.4mm 10N32
W2203
3.2mm 10N28



Ceramic Nozzle

10N46 13mm **W2208**
10N47 11mm **W2207**
10N48 10mm **W2206**
10N49 8mm **W2205**
10N50 6mm **W2204**



W2212

Short Back Cap
57Y04



W2212A

Medium 300M



W2213

Long 57Y02



W2257

Gas Lens 2.4mm
45V26



**Gas Lens
Nozzles**

54N14 13mm
W2241A
54N19 18mm
W2241B

MIG TORCHES AND SPARES

150 Amp Mig Torch

Compatible with: Telwin TW160, Binzel MB15, PARWELD 150A



Torch 3 Mtr Long		W2338
Torch Neck		W2313
Contact Tip	0.6mm	W2320
	0.8mm	W2321
	1.0mm	W2322
Tip Holder L/H		W2317A
	R/H	W2317B
Shroud		W2317
Liner for Steel Wire 3 Mtr		W2338A

250 Amp Mig Torch

Compatible With: Telwin MT25, Binzel MB25, PARWELD 250A



Torch 4 Mtr		W2340
Torch Neck		W2623
Contact Tip with 6mm Thread	0.6mm	W2352
	0.8mm	W2353
	1.0mm	W2354
Tip Holder		W2348
Shroud		W2323
Liner for Steel Wire 4 Mtr		W2347
Aluminium Wire 4 Mtr		W2346

350 Amp Mig Torch

Compatible With: Telwin MT36, Binzel MB36, PARWELD 360A



Torch 5 Mtr		W2339
Torch Neck		W2626
Contact Tip with 8mm Thread	0.8mm	W2352HD
	1.0mm	W2353HD
	1.2mm	W2354HD
	1.4mm	W2354K
	1.6mm	W2355
Tip Holder		W2343
Insulator		W2344
Shroud		W2342
Liner for Steel Wire 5 Mtr		W2344A
Aluminium Wire 5 Mtr		W2344B

Mig Torch ESAB PSF315



Mig Torch 5 Mtr Long	W2280
Contact Tip 0.8mm	W2284B
1.0mm	W2284C
1.2mm	W2284D
Tip Holder	W2284
Insulator	W2284A
Shroud	W2284E
Liner 5 Mtr	W2283

Mig Torch TWECO NO 4

Mig Torch 5 Mtr	W2285
Torch Neck	W2293
Contact Tip 0.8mm	W2286
1.0mm	W2287
1.2mm	W2288
1.6mm	W2289
Gas Diffuser 54A	W2290
Insulator 34A	W2291
Nozzle 24A62	W2292
Nozzle 24CT62S	W2294
Insulator 34CT	W2295
Liner for Steel 5 Mtr	W2296
Liner for Aluminium 5 Mtr	W2298

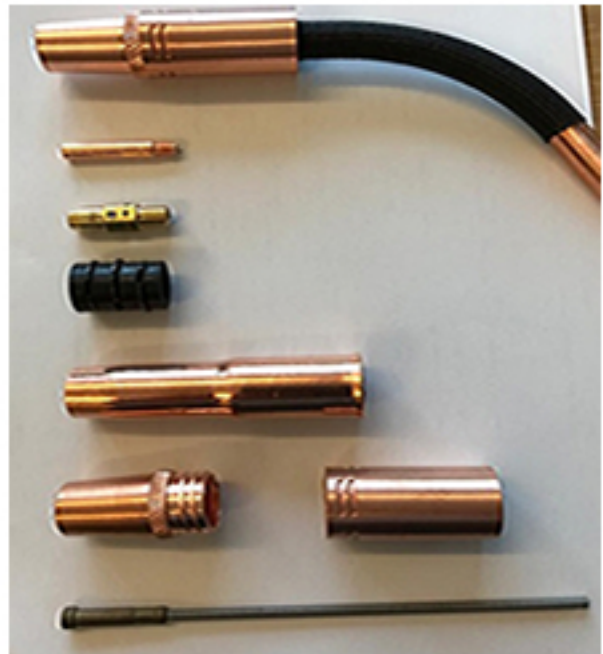

TELWIN



802425
W21503
Shroud



802423
W2500
Nozzle



802422
W21502
Swirl Ring



802420
W2499
Electrode

THERMAL DYNAMICS (SL60)



98215
Electrode 40
AMP



98213
Start
Cartridge



98207
Tip 40
AMP



98218
Shield
Cap



98244
Shield
Cap

JASIC PT60 Plasma Parts



52582
Electrode



60028
Gas Distributor



51313
Cutting
Tip



60389
Retaining
Cap

PT100 Plasma Parts



52556
Electrode



60025
Gas Distributor



Cutting Tip
51246.10 40-50 Amp
51246.11 50-60 Amp
51246.12 60-70 Amp



60500
Retaining
Cap

Hypertherm

Plasma Powermax 45



220674
Shield

220713
Retaining
Cap

220671
Nozzle
45 AMP

220669
Electrode
20-105 AMP

220670
Swirl Ring

Plasma Powermax 45XP



220818
Shield

220854
Retaining
Cap

Nozzle
220941 45 AMP
220819 65 AMP
220816 85 AMP
220990 105 AMP

220842
Electrode
45-105 AMP

220857
Swirl Ring

Plasma Powermax 80



220065
Shield

2200713
Retaining
Cap

220011
Nozzle
100 AMP

220037
Electrode

220051
Swirl Ring



120929
Shield

60495
Retaining
Cap



Nozzle
120931 60 AMP
120927 80 AMP



120926
Electrode
40-80 AMP



120925
Swirl Ring

Carbon Brushes for Bosch Power Tools



B1350

ASEIN: 0105J
BOSCH REF:
2.604.321.905
GSB18-2 20-2RE
Width: 5MM
Length:8MM
Height: 15.5MM



B1603

ASEIN: 1128JX
BOSCH REF: 22.230 24.230
GWS 20-230
Width: 6.3MM
Length:16MM
Height: 22MM



B1610

ASEIN: 1114J
BOSCH REF:
1.607.014.116
GWS 6-115
Width: 5MM
Length:8MM
Height:18MM



B1518

ASEIN: 1167JX
BOSCH REF:
1.607.014.145
GWS 7-115
Width: 5MM
Length:8MM
Height: 15.5MM



B1519

ASEIN: 1129J
BOSCH REF: 1.607.014.172
GWS9-115
Width: 5MM
Length:10MM
Height: 16MM



B1519A

ASEIN: 1199.37J
BOSCH REF:
1619P11715
GWS9-115S
Width: 5MM
Length:8MM
Height: 15MM



B1519B

ASEIN: 1199.30J
BOSCH REF:
1.607.000V53
GWS9-115S
Width: 6MM
Length:10MM
Height: 16MM



B1519C

ASEIN: 1120J
BOSCH REF: 1.617.014.135
GBH 5/7
Width: 6.3MM
Length:12.5MM
Height: 25MM



B1519D

ASEIN: 1199.09J
BOSCH REF:
3.607.014.012
GGS6
Width: 6.35MM
Length:12.5MM
Height: 22MM

Combination Spanners



Elora-no	mm	Elora-no	mm
205-5	125	205A-1/4	130
205-5.5	125	205A-5/16	140
205-6	130	205A-11/32	150
205-7	130	205A-3/8	150
205-8	140	205A-7/16	160
205-9	150	205A-1/2	180
205-10	150	2054A-9/16	195
205-11	160	205A-19/32	215
205-12	180	205A-5/8	215
205-13	180	205A-11/16	235
205-14	195	205A-3/4	255
205-15	215	205A-13/16	270
205-16	215	205A-7/8	295
205-17	235	205A-15/16	320
205-18	245	205A-1	345
205-19	255	205A-1.1/16	370
205-20	270	205A1.1/8	370
205-21	270	205A-1.3/16	390
205-22	295	205A1.1/4	420
205-23	320	205A1.5/16	420
205-24	320	205A1.3/8	460
205-25	345	205A1.7/16	460
205-26	345	205A-1.1/2	460
205-27	370	205A1.5/8	510
205-28	370	205A-1.11/16	510
205-29	390	205A1.3/4	520
205-30	390	205A-1.13/16	520
205-32	420	205A-1.7/8	520
205-33	420	205A-2	560
205-34	420	205A-2.1/16	560
205-36	460	205A-2.1/8	570
205-38	460	205A-2.3/16	570
205-41	510	205A2.1/4	570
205-46	520	205A-2.3/8	660
205-50	560	205A-2.9/16	750
205-55	570	205A-2.3/4	760
205-60	570	205A-3	810
205-65	570	205A-3.1/4	960
205-70	760		
205-75	810		
205-80	850		

ELORA

Made in Germany

Adjustable Wrenches Economy



Elora-no	Opening	mm
61-MB 6	19	150
61-MB 8	27	200
61-MB 10	30	250
61-MB 12	33	300
61-MB 15	43	380
61-MB 18	54	380
60-24A	24"	612

Ring Slogging Spanner



Elora-no	mm
86-22	165
86-24	165
86-27	180
86-28	180
86-30	190
86-32	190
86-34	190
86-36	210
86-38	210
86-41	230
86-46	242
86-50	254
86-55	268
86-60	283
86-65	300
86-70	325
86-75	325
86-80	358
86-85	358
86-90	388

1/2" Sq Drive Sockets

ELORA Made in Germany



12 Point

Elora-No.

770-LM 8
770-LM 9
770-LM 10
770-LM 11
770-LM 12
770-LM 13
770-LM 14
770-LM 15
770-LM 16
770-LM 17
770-LM 18
770-LM 19
770-LM 20
770-LM 21
770-LM 22
770-LM 23
770-LM 24
770-LM 25
770-LM 26
770-LM 27
770-LM 28
770-LM 29
770-LM 30
770-LM 32
770-LM 33
770-LM 34

6 Point

Elora-No.

771-LM 5
771-LM 5.5
771-LM 6
771-LM 7
771-LM 8
771-LM 9
771-LM 10
771-LM 11
771-LM 12
771-LM 13
771-LM 14
771-LM 15
771-LM 16
771-LM 17
771-LM 18
771-LM 19
771-LM 20
771-LM 21
771-LM 22
771-LM 23
771-LM 24
771-LM 25
771-LM 26
771-LM 27
771-LM 28
771-LM 29
771-LM 30
771-LM 32
771-LM 33
771-LM 34
771-LM 36

Reversible Ratchet



Elora-No.	Teeth	mm
770-L1D	32	370

Universal Socket



Elora- No.	mm
770-L7	75

Sliding T-Bar



Elora-No.	mm
770-L3	300

Extension Bars



Elora-No.	mm
770-L35	50
770-L4	75
770-L5	125
770-L6	250

Socket Converters



Elora- No.	Male/Female	mm
770-L11	3/4 x 1/2	45
770-S9	1/2 x 3/4	57
770-L13	3/8 x 1/2	40
770-L14	1/2 x 3/8	36

ELORA 1/2" Sq Drive

Elora-No.	Bolt	mm
3210-IN 4	M5	60
3210-IN 5	M6	60
3210-IN 6	M8	60
3210-IN 7		60
3210-IN 8	M10	60
3210-IN 9		60
3210-IN 10	M12	60
3210-IN 12	M14	60
3210-IN 14	M16	60
3210-IN 17	M20	60
3210-IN 19	M24	60
3210-IN 22	M30	60

Elora-No.	mm
3210-IN 3/16	52
3210-IN 7/32	52
3210-IN 1/4	52
3210-IN 5/16	52
3210-IN 3/8	52
3210-IN 7/16	52
3210-IN 1/2	52
3210-IN 9/16	60
3210-IN 5/8	60
3210-IN 3/4	60

Elora-No.	Bolt	mm
3210-IN 5 x 100	M6	100
3210-INL 5 x 180	M6	180
3210-INL 6 x 70	M8	70
3210-INL 6 x 100	M8	100
3210-INL 6 x 137	M8	137
3210-INL 6 x 160	M8	160
3210-INL 6 x 220	M8	220
3210-INL 7 x 100	for VW	100
3210-INL 8 x 83	M10	83
3210-INL 8 x 100	or Ford	100
3210-INL 8 x 120	M10	120
3210-INL 10 x 140	M12	140
3210-INL 12 x 140	M14	140
3210-INL 14 x 140	M16	140
3210-INL 17 x 100	M20	100
3210-INL 19 x 100	M24	100



1/2" Dr TX Torx Keys

Elora-No.	mm	(L) mm
3245-TK 20	3.86	55
3245-TX 25	4.43	55
3245-TX 27	4.99	55
3245-TX 30	5.52	55
3245-TX 40	6.65	55
3245-TX 45	7.82	55
3245-TX 50	8.83	55
3245-TX 55	11.22	56
3245-TX 60	13.25	56



1/2" Dr XZN Splined Socket

Elora-No.	mm	(L) mm
3230-XZN 5	M5	52
3230-XZN 6	M6	52
3230-XZN 8	M8	53
3230-XZN 10	M10	53
3230-XZN 12	M12	55
3230-XZN 14	M14	58
3230-XZN 16	M16	60



1/2" Dr LTXE Female Torx

Elora-No.	mm	(L) mm
770-LTXE 10	9.42	36
770-LTXE 11	10.03	36
770-LTXE 12	11.17	36
770-LTXE 14	12.9	36
770-LTXE 16	14.76	36
770-LTXE 18	16.64	38
770-LTXE 20	18.41	38
770-LTXE 24	22.1	38



3/4" Dr Hex Keys

Elora-No.	mm	(L) mm
770-SIN 14	M16-18	55
770-SIN 17	M20-22	55
770-SIN 19	M24-27	55
770-SIN 22	M30	55





Sockets



Elora-No.	Elora-No.	mm
770-S 18	770-S 3/4	50
770-S 19	770-S 16/16	50.5
770-S 21	770-S 7/8	50.5
770-S 22	770-S 15/16	51
770-S 23	770-S 31/32	53
770-S 24	770-S 1	53
770-S 25	770-S 1.1/16	55
770-S 26	770-S 1.1/8	55.5
770-S 27	770-S 1.3/16	57
770-S 28	770-S 1.1/4	58
770-S 29	770-S 1.5/16	59.5
770-S 30	770-S 1.3/8	60
770-S 32	770-S 1.7/16	62
770-S 33	770-S 1.1/2	64
770-S 34	770-S 1.9/16	66
770-S 36	770-S 1.5/8	66
770-S 37	770-S 1.11/16	69
770-S 38	770-S 1.3/4	69
770-S 41	770-S 1.13/16	70
770-S 42	770-S 1.7/8	70
770-S 46	770-S 2	75
770-S 47	770-S 2.1/16	75
770-S 50	770-S 2.2/8	77
770-S 52	770-S 2.3/16	78
770-S 54	770-S 2.1/4	78
770-S 55	770-S 2.3/8	83
770-S 60		

Socket Converters



Elora-No.	mm
770-S15	100
770-S4	200
770-S5	400

3/4" Sq Drive

Push Through Ratchet



Elora-No.	Teeth	mm
770-S1Z1	36	500

Socket Handle



Elora-No.	mm
770-S14	500

Sliding T-Bar



Elora-No.	mm
770-S3	480

Extension Bars



Elora- No.	Male/Female	mm
770-S9	1/2 x 3/4	43
770-L11	3/4 x 1/2	43
770-S11	1 x 3/4	55
780-7	3/4 x 1/2	70

Flexible Handle



Elora-No.	mm
770-S2	500

Universal Joint



Elora-No.	mm
770-S6	100

Sockets

Elora-No.	mm
780-36	70
780-38	70
780-41	70
780-46	75
780-50	75
780-55	75
780-60	80
780-65	85
780-70	88
780-75	92
780-80	103



Pry Bar



Elora-No.	mm
164	400
GROZ	mm
E9229	400
E9230	500

Reversible Ratchet



Elora-No.	Teeth	mm
780-1	32	660

Sliding T-Bar



Elora-No.	mm
780-2	640

Extension Bars



Elora-No.	mm
780-3	200
780-4	400

Socket Converters



Elora- No.	Male/Female	mm
770-S11	1 x 3/4	55
780-7	3/4 x 1	70

Screwdriver Sockets



Elora-No.		mm
780-IN 17	M20-22	90
780-IN 19	M24-27	90
780-IN 22	M30	90
780-IN 24	M33	90

Hexagon Keys, Standard



Elora-No.	mm
159-0,7	33 x 7
159-0,9	33 x 11
159-1	33 x 11
159-1,3	41 x 13
159-1,5	46,5 x 15,5
159-2	52 x 18
159-2,5	58,5 x 20,5
159-3	66 x 23
159-3,5	69,5 x 25,5
159-4	74 x 29
159-4,5	80 x 30,5
159-5	85 x 33
159-5,5	85 x 33
159-6	96 x 38
159-7	102 x 41
159-8	108 x 44
159-9	114 x 47
159-10	122 x 50
159-11	129 x 53
159-12	137 x 57
159-13	145 x 63
159-14	154 x 70
159-15	161 x 73
159-16	168 x 76
159-17	177 x 80
159-18	188 x 84
159-19	199 x 89
159-20	200 x 90
159-21	211 x 96
159-22	222 x 102
159-24	248 x 114
159-27	277 x 127
159-30	315 x 142
159-32	347 x 157
159-36	391 x 176
159A-1/6	46,5 x 15,5
159A-5/64	52 x 18
159A-3/32	58,5 x 20,5
159A-7/64	66 x 23

159A-1/8	66 x 23
159A-9/64	69,5 x 25,5
159A-5/32	74 x 29
159A-3/16	85 x 33
159A-7/32	91 x 36
159A-1/4	96 x 38
159A-9/32	102 x 41
159A-5/16	108 x 44
159A-11/32	114 x 47
159A-3/8	122 x 50
159A-7/16	129 x 53
159A-1/2	145 x 63
159A-9/16	154 x 70
159A-5/8	168 x 76
159A-3/4	199 x 89
159A-7/8	222 x 102
159A-1	277 x 127

Hexagon Keys, Long

Elora-No.	mm
159L-1,5	91,5 x 15,5
159L-2	102 x 18
159L-2,5	114,5 x 20,5
159L-3	129 x 23
159L-4	144 x 29
159L-5	165 x 33
159L-6	186 x 38
159L-7	197 x 41
159L-8	208 x 44
159L-9	219 x 47
159L-10	234 x 50
159L-11	247 x 53
159L-12	262 x 57
159L-13	277 x 63
159L-14	294 x 70
159L-17	337 x 80
159L-19	379 x 89

159LA-1/16	91,5 x 15,5
159LA-5/64	102 x 18
159LA-3/32	114,5 x 20,5
159LA-1/8	129 x 23
159LA-5/32	144 x 29
159LA-3/16	165 x 33
159LA-1/4	186 x 38
159LA-9/32	197 x 41
159La-5/16	208 x 44
159LA-3/8	234 x 50
159LA-7/16	247 x 53
159LA-1/2	277 x 63
159LA-5/8	337 x 80
159LA-3/4	379 x 89

Ball End Hexagon Keys

Elora-No.	mm
159KU-1,5	81,5 x 14,5
159KU-2	87 x 18
159KU-2,5	92,5 x 9,5
159KU-3	103 x 22
159KU-4	114 x 29
159KU-5	133 x 32
159KU-6	156 x 36
159KU-8	178 x 43
159KU-10	200 x 50
159KU-12	226 x 57
159KUA-5/32	114 x 29
159KUA-3/16	133 x 32
159KUA-7/32	142,5 x 32,5
159KUA-1/4	156 x 36
159KUA-5/16	178 x 43
159KUA-3/8	200 x 50
159KUA-1/2	293 x 63

Engineers Files, Round Pattern



Elora-No.	Hieb Cut	(L) mm	Total Length
248-1 x 150	Bastard Cut 1	150	240
248-1 x 200	Bastard Cut 1	200	310
248-1 x 250	Bastard Cut 1	250	360
248-2 x 150	Second Cut 2	150	240
248-2 x 200	Second Cut 2	200	310
248-2 x 250	Second Cut 2	250	360
248-3 x 150	Smooth Cut 3	150	240
248-3 x 200	Smooth Cut 3	200	310
248-3 x 250	Smooth Cut 3	250	360

Engineers Files, Flat Pattern



Elora-No.	Hieb Cut	(L) mm	Total Length
246-1 x 150	Bastard Cut 1	150	240
246-1 x 200	Bastard Cut 1	200	310
246-1 x 250	Bastard Cut 1	250	360
246-1 x 300	Bastard Cut 1	300	430
246-2 x 150	Second Cut 2	150	240
246-2 x 200	Second Cut 2	200	310
246-2 x 250	Second Cut 2	250	360
246-2 x 300	Second Cut 2	300	430
246-3 x 150	Smooth Cut 3	150	240
246-3 x 200	Smooth Cut 3	200	310
246-3 x 250	Smooth Cut 3	250	360
246-3 x 300	Smooth Cut 3	300	430

Engineers Files, Square Pattern



Elora-No.	Hieb Cut	(L) mm	Total Length
208-1 x 150	Bastard Cut 1	150	240
208-1 x 200	Bastard Cut 1	200	310
208-1 x 250	Bastard Cut 1	250	360
208-2 x 150	Second Cut 2	150	240
208-2 x 200	Second Cut 2	200	310
208-2 x 250	Second Cut 2	250	360
208-3 x 150	Smooth Cut 3	150	240
208-3 x 200	Smooth Cut 3	200	310
208-3 x 250	Smooth Cut 3	250	360

Engineers Files, Half Round Pattern



Elora-No.	Hieb Cut	(L) mm	Total Length
247-1 x 150	Bastard Cut 1	150	240
247-1 x 200	Bastard Cut 1	200	310
247-1 x 250	Bastard Cut 1	250	360
247-1 x 300	Bastard Cut 1	300	430
247-2 x 150	Second Cut 2	150	240
247-2 x 200	Second Cut 2	200	310
247-2 x 250	Second Cut 2	250	360
247-2 x 300	Second Cut 2	300	430
247-3 x 150	Smooth Cut 3	150	240
247-3 x 200	Smooth Cut 3	200	310
247-3 x 250	Smooth Cut 3	250	360
247-3 x 300	Smooth Cut 3	300	430

Number Punches

Elora-No.	Size of figures mm	Shank mm
400Z-2	2	6 x 65
400Z-3	3	6 x 65
400Z-4	4	7 x 65
400Z-5	5	8 x 65
400Z-6	6	9 x 70
400Z-7	7	10 x 75
400Z-8	8	11 x 75
400Z-10	10	12 x 80
400Z-12	12	14 x 80
400Z-15	15	16 x 90
400Z-20	20	18 x 100



Letter Making Punch Set

Elora-No.	Size of figures mm	Shank mm
4008-2	2	6 x 65
4008-3	3	6 x 65
4008-4	4	7 x 65
4008-5	5	8 x 65
4008-6	6	9 x 70
4008-7	7	10 x 75
4008-8	8	11 x 75
4008-10	10	12 x 80
4008-12	12	14 x 80
4008-15	15	16 x 90
4008-20	20	18 x 100



Torque Wrench



Elora-No.		
2179-60	3/8 D	10-60NM
2179-125	1/2 D	25-125 NM
2179-200	1/2 D	40-200 NM
2179-335	1/2 D	65-335 NM

Cantilever Tool Box 5 Trays



Elora-No.	Width mm	Height mm	Depth mm
810 L Empty	530	200	200

Single Open Ended Spanner



Elora-No.	(L) mm
894-30	250
894-32	260
894-34	260
894-36	300
894-38	300
894-41	340
894-50	410
894-55	460
894-60	490
894-64	530
894-70	575
894-75	610
894-80	645
894-85	690
894-95	845

Torque Wrenches



Elofort-No		Nm	Ft.lb.	(L) mm
27-125	3/8"	25-125	20-90	420
27-335	1/2"	60-335	50-250	520

Socket Sets



Elora-No.	Contents
770-XZN	XZN /m5, M6, M8, M10, M12, M14, M16

Socket Sets



Elora-No.	Contents
770-INM	4, 5, 6, 8, 10, 12, 14, 17, 19mm
770-INA	3/16, 1/4, 5/16, 3/8, 1/2, 9/16, 3/4 AF

Socket Sets



Elora-No.	Contents
770-TX	TX 20, 25, 27, 30, 40, 45, 50, 55, 60
770-TTX	TTX20, 25, 27, 30, 40, 45, 50, 55, 60

Flat Chisel

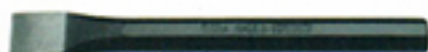

Elora-No	(L) mm	Width of edge mm	Ø mm
260-100	100	15	14 x 9
260-125	125	15	14 x 9
260-150	150	18	17 x 11
260-175	175	21	20 x 12
260-200	200	24	23 x 13
260-250	250	25	23 x 13
260-300	300	26	23 x 13
260-400	400	32	26 x 13

Pointed Chisel



Elora-No	(L) mm	Width of edge mm	Ø mm
261-150	150	6	17 x 11
261-200	200	8	20 x 12

Flat Chisel



Elora-No	(L) mm	Width of edge mm	Ø mm
262-125	125	12	10
262-150	150	16	12

Centre Punches



Elora-No.	(L) mm	Tip- Ø mm	Ø mm
265-10	120	4	10
265-12	120	5	12
265-12L	150	5	12

Chisel and Punch Sets



Elora-No	Contents
266K	262-125mm flat cold chisel 262-150mm flat cold chisel 263-125mm cross cut chisel
266KS	264-120 x 10 x 4mm taper punch 264-120 x 12 x 4mm taper punch 265-120 x 10mm centre punch

Parallel Punch Sets



Elora-No	Contents
271K	271-150 x 2 mm parallel pin punch 271-150 x 3 mm parallel pin punch 271-150 x 4 mm parallel pin punch
271KS	271-150 x 5 mm parallel pin punch 271-150 x 6 mm parallel pin punch 271-150 x 8 mm parallel pin punch

Screw Extractor Set



Elora-No	Contents
351S 5	350-6, 350-8, 350-11, 350-14, 350-18
352S 6	350-6, 350-8, 350-11, 350-14, 350-18, 350-24
353S 8	350-6, 350-8, 350-11, 350-14, 350-18, 350-24, 350-33, 350-45

Mounting Drift Punch



ELORA Punch 150mm Long



Elora-No.	No.	l/mm	d1 Ø mm	d2 Ø
E8855	259-5	180	5	12
E8856	259-6	200	6	13
E8857	259-8	200	8	16
E8858	259-9	200	9	20
E8859	259-10	230	10	22
E8860	259-11	250	11	24
E8861	259-12	280	12	27
E8862	259-14	315	14	30
E8863	259-15	340	15	32
E8864	259-16	380	16	36

Elora-No.	No.	l/mm
E8815	271-2 mm	150mm
E8816	271-2.5 mm	150mm
E8817	271-3 mm	150mm
E8818	271-3.5 mm	150mm
E8820	271-4 mm	150mm
E8821	271-4.5 mm	150mm
E8822	271-5 mm	150mm
E8823	271-6 mm	150mm
E9924	271-7 mm	150mm
E8825	271-8 mm	150mm
E8826	271-9 mm	150mm
E8827	271-10 mm	150mm
E8827A	271-12 mm	150mm

Ball End Hexagon Key Sets in Plastic Holder



Elora-No.	Contents
159SKU	1,5;2,5;3;4;5;6;8;10mm
159SKUA	0,05; 1/16; 5/64; 3/32; 1/8; 5/32; 3/16; 7/32; 1/4; 5/16 AF

Wad Punch Sets



Elora-No.	Inhalt Ø	Content Ø
285 S8	3;6;8;10;12;16;20;25mm	
285 S10	3; 5; 7; 8; 10; 13; 16; 19; 22; 25mm	

Strap Wrench



Elora-No.	Drive
187-180	1/2"
1.87E-178	Spare Strap

Strap Wrench



Elora-No.	Handle (L)
187-280	280
187-160	230

Standard Pullers



Elora-No.	Span width mm	Span depth mm
173-80	80	90
173-130	130	90
173-160	160	150
173-200	200	150
173-250	250	200
173-350	350	200
173-520	520	200
173-640	640	225

Pullers

Elora-No.	Span width mm	Span depth mm
320-150	150	80
320-200	200	130

